

# SERENE SERIES 2

## REMOTE CONTROLLER

Operation Manual

Suitable for  
Serene Series 2

WRE-026CS

WRE-035CS

WRE-050CS

WRE-072CS

WRE-085CS



### IMPORTANT NOTE:

Please read this manual carefully before operating your new remote control and keep it near the unit for future reference.

*That's better. That's Actron.*



**ActronAir**

## Table of Contents

<b>01. Remote Controller Specifications .....</b>	<b>3</b>
<b>02. Handling the Remote Controller .....</b>	<b>3</b>
<b>03. Button and Functions .....</b>	<b>4</b>
<b>04. Remote Screen Indicators.....</b>	<b>5</b>
<b>05. Basic Functions .....</b>	<b>6</b>
05.01. Mode Operation.....	6
05.02. Setting the Timer.....	7
<b>06. How To Use Advanced Function .....</b>	<b>11</b>
06.01. Swing Function .....	11
06.02. LED Display .....	11
06.03. Quiet Function .....	12
06.04. Freeze Protection (FP) Function .....	12
06.05. LOCK Function .....	12
06.06. BOOST Function .....	12
06.07. ECO/GEAR Function.....	12
06.08. Proximity Sensor.....	13
06.09. SET Function.....	13

## 01. Remote Controller Specifications

<b>Model</b>	RC-02
<b>Rated Voltage</b>	3.0V( Dry batteries 1.5V AAA × 2)
<b>Signal Receiving Range</b>	8m
<b>Environment</b>	-5°C~60°C

## 02. Handling the Remote Controller

### Inserting and Replacing Batteries

Your air conditioning unit comes with two batteries. Put the batteries in the remote control before use.

1. Slide the back cover from the remote control downward, exposing the battery compartment.
2. Insert the batteries, paying attention to match up the (+) and (-) ends of the batteries with the symbols inside the battery compartment.
3. Slide the battery cover back into place.

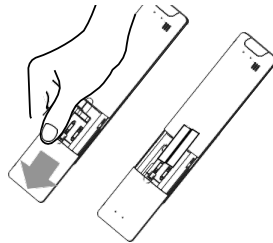

### BATTERY NOTES

For optimum product performance:

- Do not mix old and new batteries, or batteries of different types.
- Do not leave batteries in the remote control if you don't plan on using the device for more than 2 months.
- Do not use rechargeable batteries.

### BATTERY DISPOSAL

Waste Electrical & Electronic Equipment Disposal Guideline

- Do not dispose off the waste electrical & electronic equipment with local council waste. These must be disposed off through the council designated hazardous waste collection centre.
- The equipment may contain hazardous substances, improper or incorrect disposal may have a negative effect on human health and on the environment.
- Remove batteries and separated from the rest of the product before disposing.

### CAUTION

When the batteries are removed, the remote controller erased all settings. After inserting new batteries, remote controller and the Air conditioning may have a different settings.

To sync their settings, press any button or adjust the settings from remote controller. The Air conditioning will follow the new remote controller settings.

### Tips For Using Remote Control

1. Use the remote controller within a distance of 8 metres from the appliance, pointing it towards the unit. Reception is confirmed by a beep.
2. The air conditioner will not receive the command if curtains, doors, other materials and direct sunlight block the signals from the remote controller to the indoor unit.
3. Remove batteries if the remote will not be used more than 2 months.

### 03. Button and Functions

Before you begin using your new air conditioner, make sure to familiarize yourself with its remote control. The following is a brief introduction to the remote control itself. For instructions on how to operate your air conditioner, refer to the **Basic Functions** section of this manual.

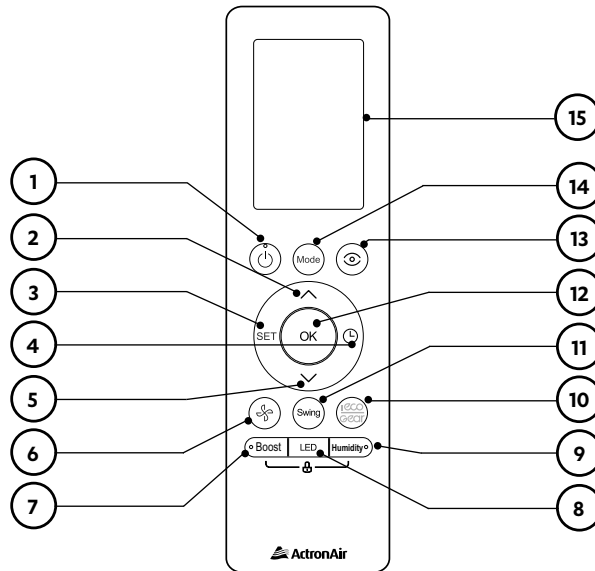

- 1 ON/OF**  
This button turns the air conditioner On or Off.
- 2 TEMP UP**  
Increases temperature in 0.5°C increments. Maximum temperature is 30°C.
- 3 SET**  
Scrolls through operation functions as follows:  
Breeze away → Active Clean → Fresh   
→ Sleep → Follow Me → AP Mode →  
Breeze away → .....  
The selected symbol will flash on the display area, press the **OK** button to confirm.
- 4 TIMER**  
Set timer to turn unit On or Off.
- 5 TEMP DOWN**  
Decreases temperature in 0.5°C increments. Min. temperature is 16°C.
- 6 FAN SPEED**  
Selects fan speeds in the following order: Au (auto) → 20% → 40% → 60% → 80% → 100%.
- 7 Boost**  
Enables unit to reach preset temperature in shortest possible time
- 8 LED**  
Toggles the LED display and buzzer of the air conditioner buzzer to On and Off.
- 9 Humidity Mode**  
Adjust the room humidity during Dry in a range of 35% ~ 85%. Press this button to increase the humidity in 5% increments.  
**NOTE:** After setting, the humidity settings will display on the screen.
- 10 EGO/GEAR**  
Press this button to enter the energy efficient mode in a sequence of following:  
ECO → GEAR (75%) → GEAR (50%) → Previous setting mode → ECO .....
- 11 Swing**  
Starts and stops the horizontal louver movement. Hold down for 2 seconds to initiate vertical louver auto swing feature.
- 12 OK**  
Used to confirm the selected functions.
- 13 Eco Intelligent Eye**  
Used to detect the occupancy in the room to save energy.
- 14 Mode**  
Scrolls through operation modes as follows:  
**AUTO → COOL → DRY → HEAT → FAN → AUTO**
- 15 Screen**  
Displays the setting, indicators and operation conditions.

## 04. Remote Screen Indicators

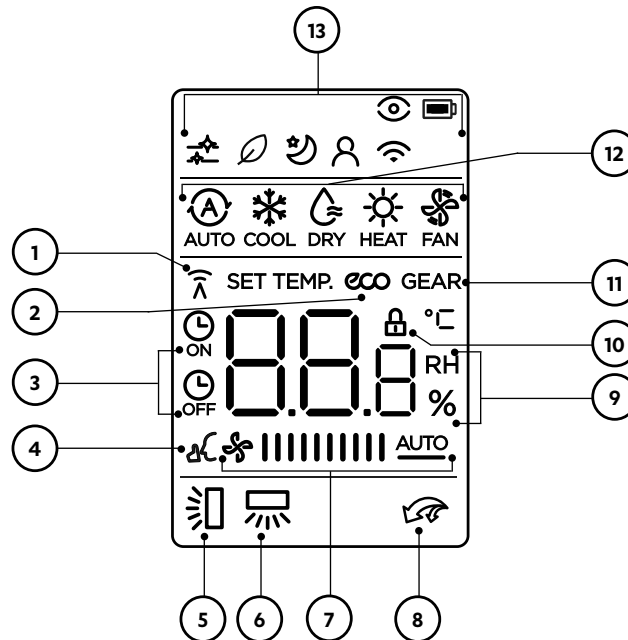

① **Transmission Indicator**

⏏ Lights up when remote sends signal to indoor unit.

② **ECO**

ECO Displays when ECO feature is activated.

③ **TIMER ON/OFF**

⌚ ON Timer On display.  
⌚ OFF Timer Off display.

④ **Quiet**

🔇 Quiet feature display.

⑤ **HORIZONTAL LOUVER**

🌀 Swing feature displays.

⑥ **VERTICAL LOUVER**

🌀 Auto Swing feature displays.

⑦ **FAN SPEED**

Displays selected fan speed:

Quiet	🌀 I	1%
	🌀 II	2% - 20%
LOW	🌀 IIII	21% - 40%
MED	🌀 VIIII	41% - 60%
HIGH	🌀 XIIIIII	61% - 80%
	🌀 XVIIIIII	81% - 100%
AUTO	🌀 XVIIIIII	<u>AUTO</u>

This fan speed can not be adjusted in AUTO or DRY mode.

⑧ **BOOST MODE**

🌀 Boost feature displays.

⑨ **TEMPERATURE/TIMER/FAN/SPEED**

Displays the set temperature by default or fan speed or timer setting when using TIMER ON/OFF functions.

- Temperature range: 16°C - 30°C (60°F - 86°F)
- Timer setting range: 0-24 hrs
- Fan speed setting range: Au - 100%
- Humidity setting range: 35% - 85%

This display is blank when operating is FAN mode.

**Note:** To display temperature in °F, press and hold the up and down arrows for 3 seconds while the remote power is on.

⑩ **LOCK**

🔒 Displays when LOCK feature is activated.

⑪ **GEAR**

Displays when GEAR feature is activated.

⑫ **Mode**

Displays the current mode including:



⑬ **Information**

Information is displayed when the functions are in use.

- 🌀 - Breeze Away Display
- 👁️ - ECO Intelligent Eye Display
- 🔋 - Low Battery Detection Display (If flashes)
- 🌿 - Active Clean Feature Display
- 🍃 - Fresh Feature Display
- 🌙 - Sleep Mode Display
- 👤 - Follow Me Feature Display
- 📶 - Access Point Mode (AP Mode)

## 05. Basic Functions

### 05.01. Mode Operation

**NOTE**

**Setting Temperature Operation**

- The operating temperature range for units is 16-30°C.
- You can increase or decrease the set temperature in 0.5°C increments.

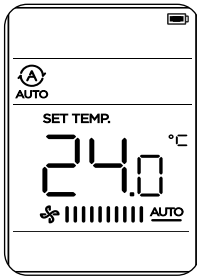

**AUTO Mode**

In **AUTO** mode, the unit will automatically select the COOL, FAN, HEAT or DRY function based on the set temperature.

1. Press the (Mode) button to select **AUTO**.
2. Set your desired temperature using the ^ or v buttons.
3. Press the (Power) button to start the unit.

**NOTE**

FAN SPEED is disabled in AUTO mode.

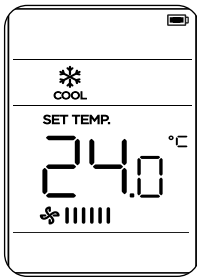

**COOL Mode**

In **COOL** mode, the unit will cool the room to the desired temperature.

1. Press the (Mode) button to select **COOL** mode.
2. Set your desired temperature using the ^ or v buttons.
3. Press the (Fan) button to select the fan speed in a range of Au-100%.
4. Press the (Power) button to start the unit.

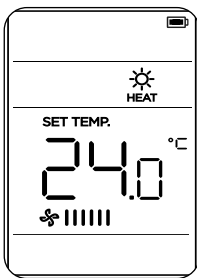

**HEAT Mode**

1. Press the (Mode) button to select **HEAT** mode.
2. Set your desired temperature using the ^ or v buttons.
3. Press the (Fan) button to select the fan speed in a range of Au-100%.
4. Press the (Power) button to start the unit.

**NOTE**

As outdoor temperature drops, the performance of your unit's HEAT function may be affected.

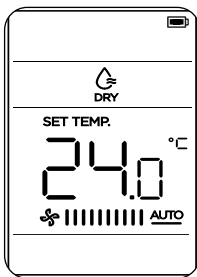

**DRY Mode (Dehumidifying)**

1. Press the (Mode) button to select **DRY** mode.
2. Set your desired temperature using the ^ or v buttons.
3. Press the (Power) button to start the unit.

**NOTE**

The Fan Speed is automatically set to AUTO while in the DRY mode.

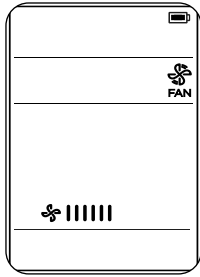

**FAN Mode**

1. Press the button to select **FAN** mode.
2. Press the button to select the fan speed in a range of Au-100%.
3. Press the button to start the unit.

**NOTE**

Set temperature is disabled in FAN mode. As a result, the remote control's LCD screen will not display temperature.

**CAUTION**

Do not put your fingers in or near the blower and suction side of the unit. The high-speed fan inside the unit may cause injury.

**05.02. Setting the Timer**

**Timer ON (Auto-On Operation)**

The TIMER ON feature is useful when you want the unit to turn off automatically at desired time.

**Example:**

To start the air conditioner in 6 hours.

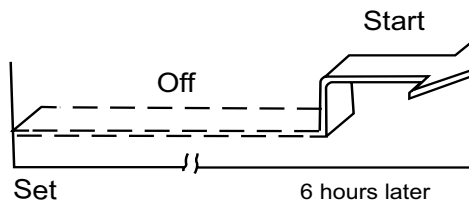

1. While the unit is OFF, press the button.
2. Press the or buttons to adjust the time.

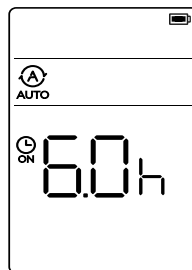

3. Point the remote controller to the indoor unit and wait for 1 second. The indicator will show in the remote controller and in the indoor unit panel to indicate that this function is activated.

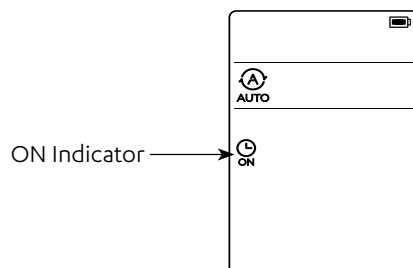

### Timer OFF (Auto-OFF Operation)

The TIMER OFF feature is useful when you want the unit to turn off automatically at desired time.

#### Example:

To turn OFF the air conditioner in 10 hours.

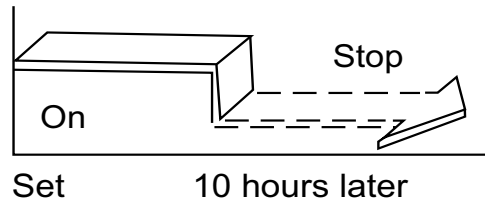

1. While the unit is ON, press the button twice until timer indicator is shown.
2. Press the or buttons to adjust the time.

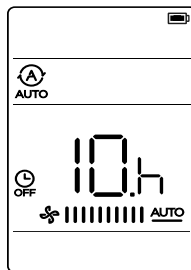

3. Point the remote controller to the indoor unit and wait for 1 second. The indicator will show in remote controller and in the indoor unit panel to indicate that this function is activated.

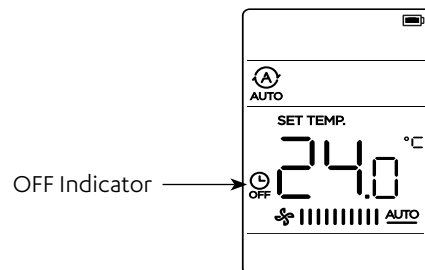

### Combined Timer (Setting both ON and OFF timers simultaneously)

TIMER OFF → TIMER ON (On Stop-Start operation)

This feature is useful when you want to stop the air conditioner after you go to bed, and start it again in the morning when you wake up or when you return home.

#### Example:

To stop the air conditioner 2 hours after setting and start it again 10 hours after setting.

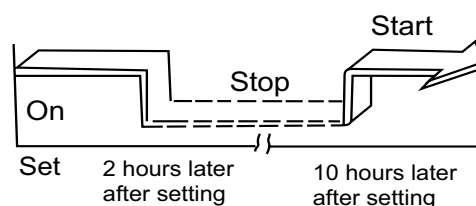



1. While the unit is ON, press the button twice until timer indicator is shown.
2. Press the or buttons to adjust the time.

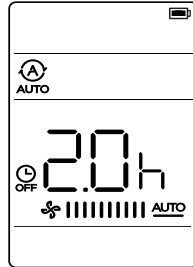

3. Point the remote controller to the indoor unit and wait for 1 second. The indicator will show in remote controller and in the indoor unit panel to indicate that this function is activated.
4. Press the button until timer indicator is shown.
5. Press the or buttons to adjust the time.

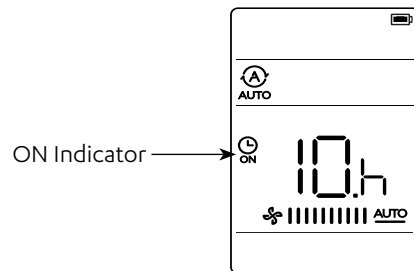

6. Point the remote controller to the indoor unit and wait for 1 second. Both the and indicators will show, this means that the function is activated.

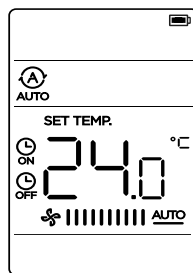





### TIMER ON → TIMER OFF (Off – Start – Stop operation)

This feature is useful when you want to start the air conditioner before you wake up and stop it after you leave the house.

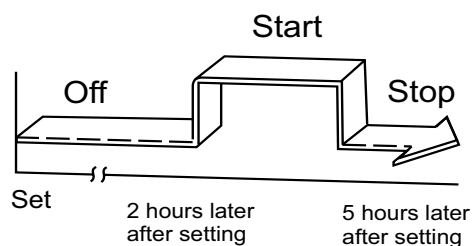



#### Example:

To start the air conditioner in 2 hours after setting, and stop it 5 hours after setting.

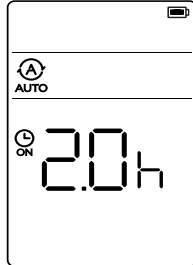



1. While the unit is OFF, press the  button until timer  indicator is shown.
2. Press the  or  buttons to adjust the time.

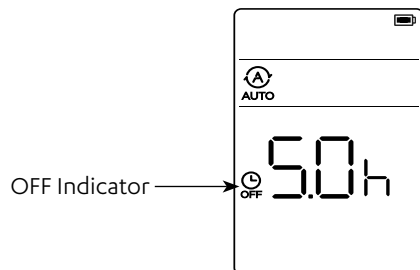

3. Point the remote controller to the indoor unit and wait for 1 second. The  indicator will show, means that the function is activated.
4. Press the  button until timer  indicator is shown.
5. Press the  or  buttons to adjust the time.



6. Point the remote controller to the indoor unit and wait for 1 second. Both the  and  indicators will show, means that the function is activated.

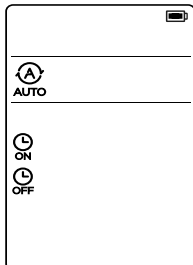

## NOTE

When setting the TIMER, the adjustable increment is 30 minutes up to 10 hours. After 10 hours the increment will be 1 hour up to 24 hours.

## NOTE

Indoor unit must show **on** or **OF** when button is pressed. If this does not happen timers will show as set on remote control but will not function on the unit.

## 06. How To Use Advanced Function

### 06.01. Swing Function

#### Setting vertical angle of airflow

While the unit is on, use the  button to set the direction (vertical angle) of airflow.

1. Press the  button to activate the louvre. The vertical louvre will swing up and down automatically.
2. Press it again to stop the automatic function.

#### NOTE

Continue pressing the  button will adjust the vertical airflow angle in five different position. Keep pressing the button until the direction you prefer is reached.



#### Setting horizontal angle of airflow

While the unit is on, use the  button to set the direction (horizontal angle) of airflow.

1. Press and hold the  button for more than 2 seconds to activate the louvre. The vertical louvre will swing left and right automatically.
2. Press and hold it again to stop the automatic function

#### NOTES

When using COOL and DRY mode, do not set vertical louvre to the minimum angle for long periods of time. This can cause water to condense on the louvre blade, which may drop on your floor or furnishings. See Fig. 1

When using COOL or HEAT mode, setting the vertical louvre to the minimum angle can reduce the performance of the unit due to the restricted air flow.

Do not move the louvre by hand. This will cause the louvre to become out of sync. If this occurs, reset mains power supply isolator of the air conditioning to restart the unit. This will reset the louvre.

During Pre-Heat function louver will be in a default position.

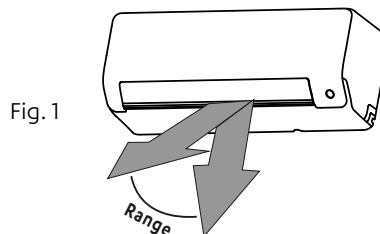



Fig. 1

### 06.02. LED Display



1. Press the **LED** button to activate or de-activate the display on the indoor unit.
2. Press and hold the **LED** button for more than 5 seconds until it beeps, release. Then press and hold again for 5 seconds then release after beeps.
3. After few seconds the room temperature shows.
4. To revert to previous display, repeat steps 2 and 3. To revert the change press **LED** button until set point shows on the indoor unit.

## 06.03. Quiet Function

1. Press and hold the  button for more than 2 seconds to activate Quiet Function. Quiet icon will display to indicate it is activated. The compressor will run at a reduced capacity to minimize the operational noise.





### NOTE

Due to low compressor frequency operation, this may result in insufficient cooling and heating capacity.

2. Holding  button again for 2 seconds turns off quiet function.
3. Pressing the  button will also cancel Quiet Mode.

## 06.04. Freeze Protection (FP) Function





In heating operation, the preset temperature of the air conditioner can be set to 8°C. This will keep the room temperature steady at 8°C and will prevent the house from freezing when it is unoccupied in severe weather. This will give the occupant a better head start when they go back home and turn ON the air conditioner.

While the system is in heat mode and 16°C, press the  buttons twice within 1 second. The unit will operate at high indoor fan speed with temperature automatically set to 8°C and display **FP** on the indoor unit. Press the  or  or  or  or  buttons to cancel this operation.

### NOTE

The indoor panel and remote control will not indicate 8°C during FP Function.

## 06.05. LOCK Function

1. Press and hold the  and  buttons for at least 5 seconds to activate lock function. Lock icon will display above the set temperature to indicate that the remote control buttons are locked.
2. Press and hold the  and  buttons for 2 seconds to de-activate lock function.

### NOTES

When pressing any button, the lock icon will flash to indicate that the remote-control buttons are locked. All buttons are disabled whilst control has lock function ON.

## 06.06. BOOST Function

Boost function is available on heating and cooling to accelerate the time it takes to reach the set point.

## 06.07. ECO/GEAR Function

Press the  button to enter energy efficient mode in the following sequence.

ECO → GEAR (75%) → GEAR (50%) → Previous setting mode → ECO .....

### NOTE

This function is only available under cooling mode.

### ECO Operation

1. While in cooling mode, press the  button. The set temperature will automatically adjust to 24°C Auto fan speed to save energy. Energy savings will take effect only when the initial set temperature is below 24°C.
2. If the set temperature is already above 24°C, the fan speed will change to Auto, the set temperature will remain unchanged.

## NOTES

Pressing the  button or changing the mode or adjusting the set temperature to less than 24°C will cancel ECO Operation.

Once ECO is activated Fan can be adjusted and **ECO** will be displayed on the LED.

### GEAR Operation

Gear mode is a setting that can limit the energy consumption output of the air conditioner if the end user desires reduction in their overall system energy usage.

This will impact performance in some conditions.

Press the  button to enter the following:

75%(up to 75% electrical energy consumption)



50%(up to 50% electrical energy consumption)



Previous setting mode.



### 06.08. Proximity Sensor

Proximity Sensor Function uses the indoor unit built-in infrared sensor to detect the room is occupied. When the occupant is away for 30 minutes (or more), the unit will automatically lower the system's performance to save energy.

The unit will automatically resume operation if the infrared sensor detects movements or activity inside the room again.

When activated, remote control will display .

### 06.09. SET Function

1. Press the **SET** button to enter the function setting.
2. Keep pressing the **SET** or  or  buttons to select the desired function. The symbol of the selected function will flash on the remote control display.
3. Press the **OK** button to confirm.

**Available SET functions are as follows:**

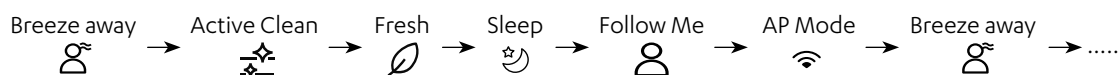

#### • Breeze Away Function

This function prevents a direct airflow blowing on the occupants for more comfortable ambience. This is achieved by aiming the louvre higher to avoid direct airflow.

## NOTE

This feature is available under Cool, Fan and Dry mode only.

- **Active clean function**

The Active Clean Function washes away accumulated dust, mold, and grease that may cause odors when it adheres to the heat exchanger. The unit will automatically freeze the heat exchanger and then rapidly thaw the frost to wash and drain away the accumulated dirt.

When this function is activated, the indoor unit display window shows **CL**, after 20 to 45 minutes, the unit will turn off automatically and cancel Clean function and return to previous operation.

- **Fresh Function**

When the FRESH function is initiated, the Ionizer/Plasma Dust Collector (depending on models) is energised and will help to remove pollen and impurities from the air.

- **Sleep Function**

When sleep function is activated it adjusts and maintains the temperature while you sleep and can save energy. For more detail on this function please refer to **Sleep Operation in Owner's Manual**.



### NOTE

The SLEEP function is not available in **FAN** or **DRY** mode.

- **Follow Me Function**

The FOLLOW ME function enables the remote control to measure the room temperature at its current location and send this signal to the air conditioner at a 3 minute interval.

Measuring room temperature from the remote control (instead from indoor unit temperature sensor) will enable the air conditioner to optimise the temperature around the user to ensure maximum comfort.

1. Select follow Me  in set menu.
2. To activate, press and hold the  button for at least seven seconds. **on** will display on the screen for two seconds.

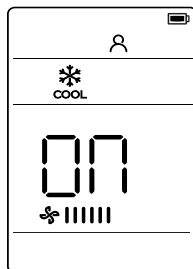

3. To de-activate press and the  button for at least seven seconds. **OF** will display on the screen for two seconds.

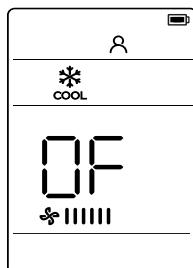

**THIS PAGE WAS INTENTIONALLY LEFT BLANK**



# ActronAir

*That's better. That's Actron.*

[actronair.com.au](http://actronair.com.au)

1300 522 722

