HERCULES AIR CONDITIONING SYSTEM CONTROL INTERFACE

Operating Instructions

Model Number
CP10



Please Read This Manual

Congratulations on your purchase of an ActronAir air conditioning system. This unit has been designed and manufactured with the highest quality standard in mind.

Please read this manual thoroughly and keep it near the unit for future reference.

CONTENTS

General Information

General Information	3
Storage & Operating Conditions	4
Waste Electrical & Electronic Equipment Disposal Guidelines	4
Safety and Operational Precautions	5
Parts & Components Identification	6
Advanced Features	7

Basic Operation

Control Interface Functions	8
Initialisation Displays - Status Indications	9
Defrost Operation Indications	10
Menu Tree Diagram (Consumer / End User Menu)	11
Sub-Menu Level Descriptions	12
Operation Mode	13
Turn Unit ON/OFF via Control Interface	14
Setting Room Temperature	15
Setting Supply Air Pressure Setpoint	16
Setting Filter Pressure Alarm Setpoint	17

7- Day Programming Operation

Setting the Clock	18
7- Day Programming	20
After Hour Timer	22
Day Light Saving Time Enable	23
Day Light Saving Time Disable	25

Monitoring Menu

Status (Read Only Menu)	26
Data Logger (Read Only Menu)	27

Additional Features

Dual Control Operation (Mimic Logic)	28
Controllers Compatibility Matrix for Dual Control	28
Alarm Matrix	29
Trouble Shooting Guide	30
Maintenance	31
System Information	33

GENERAL INFORMATION

CONGRATULATIONS! On your purchase of the latest ActronAir “Hercules” air conditioning system. With the application of an intelligent interactive software technology controller, this system has been designed to give you many years of reliable service and the convenience of menu-driven control. Your controller is manufactured from the highest quality materials and passed numerous “in house” and “external” inspection procedures to ensure years of satisfactory operation.

IN THIS MANUAL, You will find instructions on how to program and utilise the many advanced features this controller has to offer. Please take time to familiarise yourself with all these features, apply their functions to suit your optimum comfort requirement and achieve energy cost savings at the same time. Thoroughly read this manual in order to ensure correct installation and the safe utilisation of your ActronAir air conditioner.

IMPORTANT NOTICE, ActronAir base the development of its air conditioning products on more than 20 years of experience in HVAC, sound & continuous investments in technological innovations and product improvements, advancement in manufacturing processes and quality control through 100% functional product testing. However, ActronAir cannot guarantee that all the aspects of the product and the software included with the product respond to the requirements of final application, despite the product being developed according to state of the art technology. The customer, both end user/specifier and installer, assume all liability and risks relating to the configuration of the product in order to reach the expected results in relation to the specific design and system installation. ActronAir, based on specific agreements, may be consulted for the positive commissioning, installation and application of the unit, however in no case does ActronAir accept liability for the correct operation of the final equipment / system.

Your ActronAir air conditioning unit is one of the most advanced & innovative products in the market. Its operation is specified in the technical documentation supplied with the product or which can be downloaded from our website: www.actronair.com.au. Your air conditioner requires setup/configuration/programming in order to be able to operate in the best possible way to suit your requirement. Failure to complete such operations, may result in malfunction and/or damage to the unit, for which ActronAir accepts no liability.

Installation, commissioning and other technical services must only be carried out by a qualified technician. Ensure that the unit installation complies with all relevant council regulations and building code standards. All electrical wiring must be in accordance with current electrical authority regulations and all wiring connections to be as per electrical diagram provided. Always use appropriate PPE for your safety and protection. Make sure that any safety guards and covers are always firmly secured and not damaged. WH&S rules and regulations must be observed at all times and will take precedence during installation process and operation of the unit.

In addition, the following instructions must be observed:

Prevent the electrical components and electronic circuits from getting wet.

- Do not install the controlling devices in a particularly hot environment as extreme temperatures may damage the electronic equipment.
- Do not attempt to open the controller and other electronic devices in any way other than described in this manual.
- Do not drop, shake or hit the devices, which can cause irreparable damage to its internal circuits and mechanisms.

- Do not use corrosive chemicals, solvents or other aggressive detergents to clean the unit and the control interface.
- Do not use the unit for applications other than those specified in the technical manual. Contact ActronAir for technical data.
- Do not install the unit in environment with highly flammable, combustible and/or explosive articles and materials.
- The product, particularly the controlling devices, must be stored and installed in a location that complies with the temperature and humidity limits specified in this manual.

ActronAir is constantly seeking ways to improve the design of its products, therefore specifications are subject to change without prior notice. Please check with your Customer Care Department on toll free number: **1800 119 229**.

Storage & Operating Conditions

- Storage conditions: -20 to 70°C, 90% RH non-condensing
- Operating conditions: -10 to 60°C, 90% RH non-condensing

Waste Electrical & Electronic Equipment Disposal Guidelines



1. Do not dispose of the waste electrical & electronic equipment with local council waste. These must be disposed of through the council designated hazardous waste collection centre.
2. The terminal contains a battery that must be removed and separated from the rest of the product before disposing of the terminal.
3. The equipment may contain hazardous substances, improper or incorrect disposal may have a negative effect on human health and on the environment.

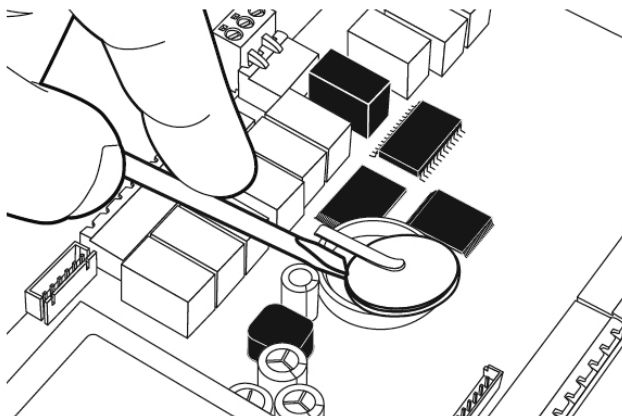

SAFETY AND OPERATIONAL PRECAUTIONS



SAFETY PRECAUTIONS

1. Read all instructions in this manual before operating the air conditioning unit. Failure to do so may result in damage to the unit and void your warranty.
2. Turn-Off power from mains supply by removing fuse or switching the circuit breaker to the "Off" position before installation or servicing this control interface.
3. Follow sound Lock Out & Tag Out procedures to ensure that power supply is not re-energised accidentally.
4. This control interface has power supply from the control board via telephone connector, with voltage of 18/30VDC protected by 250mA external fuse & maximum power input of 0.8W. Ensure that this unit is not installed on voltages higher than 30V DC supply.
5. Installation and/or servicing must be carried out by a qualified installer or technician.
6. Ensure that the unit installation complies with relevant council regulations and building code standards. All electrical wiring must be in accordance with current electrical authority regulations and all wiring connections to be as per electrical diagram provided.
7. WH&S rules and regulations must be observed and will take precedence during installation process.
8. Only use this wall controller with an ActronAir air conditioner as described in this operating manual.



OPERATIONAL PRECAUTIONS

ACCESS PANELS AND GUARDS: NEVER remove any access panels or guards as this could cause injury from electric shock and burns from extremely hot components. Never allow any bodily parts such as fingers or objects to protrude through the fan guards or any other opening as they could cause personal injury and damage the air conditioner.

RETURN AIR FILTER: The air conditioner must never be operated without a return air filter as this will allow a build up of dust or dirt on the indoor coil. This is very difficult to clean and can cause the system to operate inefficiently or even fail.

CRANKCASE HEATER PRECAUTION: The main power (switch board) to the system must be kept ON at all times to prevent damage to the outdoor compressor. Should the main power be disconnected or interrupted for 6 hours or longer, then no attempt should be made to start the system for 2 hours after the power has been restored to outdoor unit. This allows the compressor to warm up, and remove any liquid refrigerant that may cause damage.

PARTS & COMPONENTS IDENTIFICATION

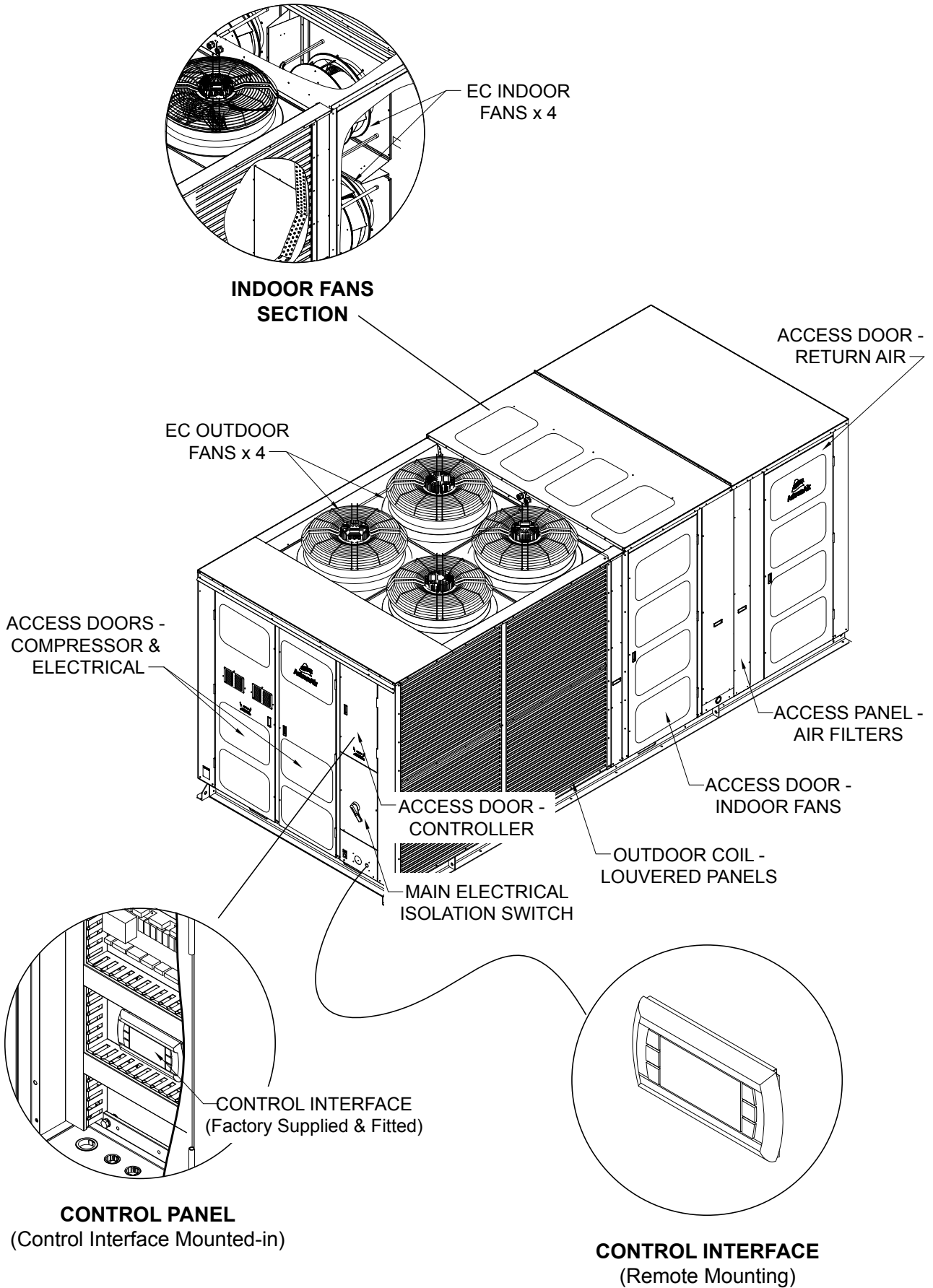

CONTROL PANEL
(Control Interface Mounted-in)

CONTROL INTERFACE
(Remote Mounting)

ADVANCE FEATURES

1	<p>Menu Tree Based Program Navigation The control system features ease of operation via menu tree</p>
2	<p>LCD Display The LCD displays the system mode, operation and fault diagnostics log.</p>
3	<p>Auto-Restart After Power Failure The Hercules control system will automatically restart the air conditioner to the previous state after power failure.</p>
4	<p>7- Day Programmable Time Clock The control panel can be programmed on each day of the week to turn ON and OFF in order to satisfy your requirement and to provide total control operation.</p>
5	<p>Dual Controller Operation (Optional) Two controllers can be installed on the Hercules system. This function is most suitable in the application of BMS control and remote monitoring. Either of the controllers can control the air conditioning system and mimic each other, displaying the same control parameters for ease of system control management.</p>
6	<p>Automatic Compressor Run Time Management The operations of the two compressors are automatically managed in a way that the running time & load are equally distributed between the two compressors.</p>
7	<p>Auto Defrost Function (Heating Mode) At certain outdoor conditions (low temperature) there may be a build up of frost on the outdoor heat exchanger. This gradual build up of frost reduces the performance of the air conditioner. The Hercules control system detects this frost build up and will automatically activate the defrost mode.</p>
8	<p>Hot Start Function (Heating Mode) When the air conditioner starts in heating mode, the indoor fan is delayed for a short period of time, this allows the heat exchanger to warm up before the air flow starts, thus preventing cold drafts. The hot start feature also activates itself when the system finishes defrosting.</p>
9	<p>Fault Diagnostics In the unlikely event that a fault develops with the air conditioner the control system will diagnose the fault (where possible) and display a date & time stamped fault log, with up to 100 events memory.</p>
10	<p>Filter Pressure Alarm The control system automatically measures the air pressure differential between the air filters inlet and outlet sides. This is the Filter Pressure Alarm Setpoint, which when triggered sends an alarm fault log, indicating that the filters need to be checked for cleaning.</p>

CONTROL INTERFACE FUNCTIONS

CONTROL INTERFACE FRONT VIEW

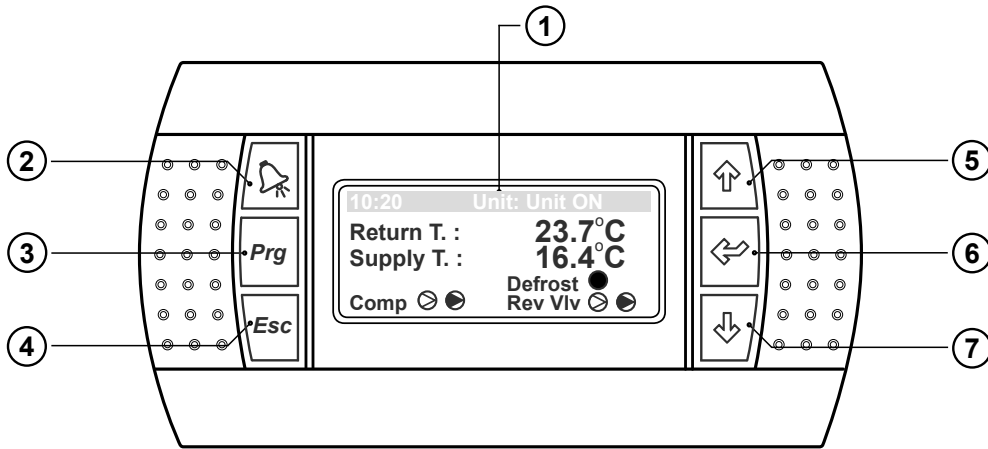

- ① **LCD Display**
Displays the setting and operation conditions (see menu page for details).
- ② **Alarm / Reset Button**
Alarm Indication and Reset Button.
- ③ **Program Button**
To bring-up programming Main Menu screen. (Display will revert back to default screen after 5 minutes idle time at any stage of programming).
- ④ **ESC Button**
To exit programming menu.
- ⑤ **Scroll Up / Increment Button**
To scroll up from existing menu or to increase setting parameter.
- ⑥ **Enter Button**
To lock the selected menu or to enter set parameters.
- ⑦ **Scroll Down / Decrement Button**
To scroll down from existing menu or to decrease setting parameter.

SYSTEM DEFAULT SCREEN

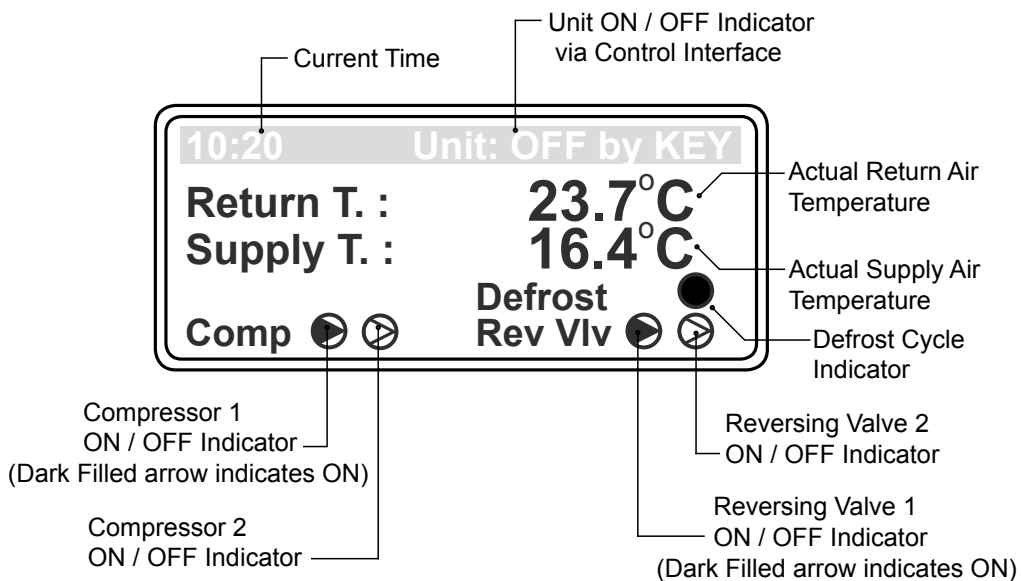

INITIALISATION DISPLAYS - STATUS INDICATIONS

POWER-UP (INITIALIZATION DISPLAYS)

Display Progression

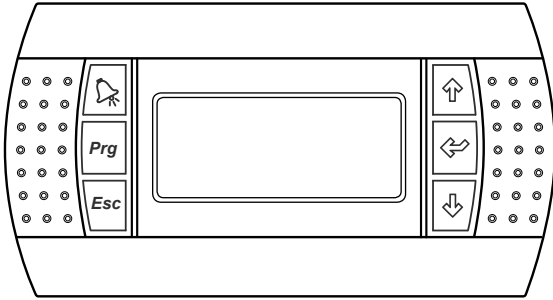

When the control interface is powered "ON" for the first time, The display will be blank for 5 - 10 seconds

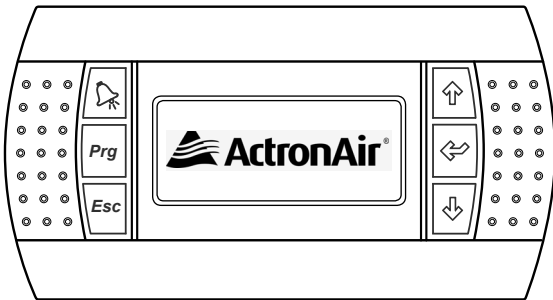

ActronAir logo will then be displayed for the next 5 - 10 seconds

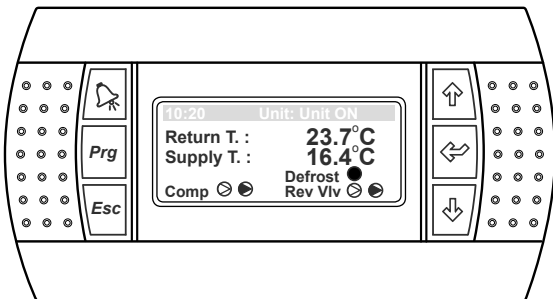

System Screen (default) provides an overview of system status, showing the Return Temperature, Supply Temperature, Compressors, Reversing Valves ON/OFF status and System Defrost indicator.

COMPRESSORS & REVERSING VALVES STATUS INDICATIONS

Display Progression

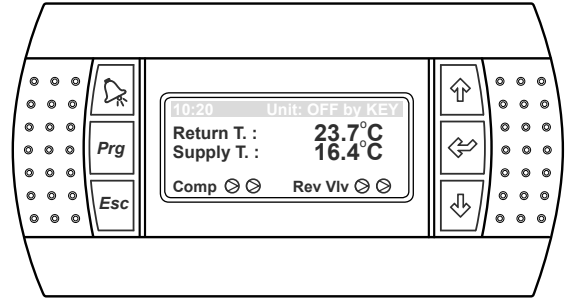

Both Compressors & Reversing Valves are Off, as indicated by clear triangles

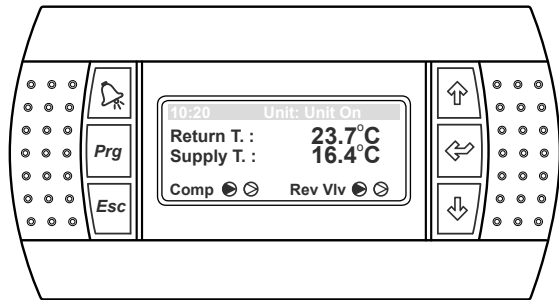

Compressor 1 & Reversing Valve 1 are On. (System in Heat Mode), first triangles are darkened

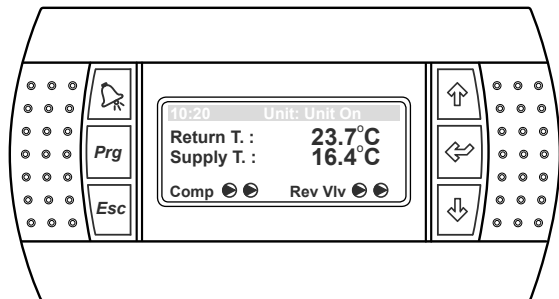

Compressors 1 & 2 and Reversing Valves 1 & 2 are On. (Systems are in Heat Mode), all triangles are darkened

DEFROST OPERATION INDICATIONS

Compressor 1 Defrost Operation

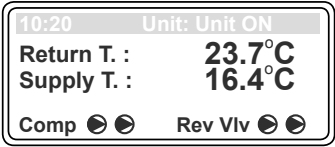
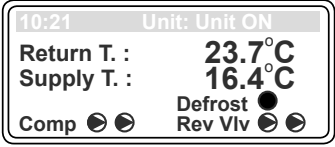
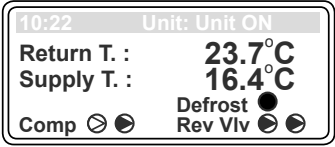
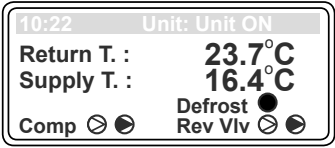
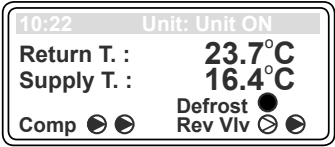
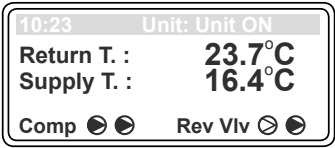
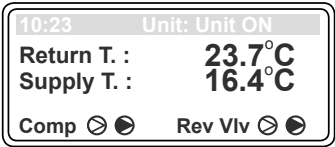
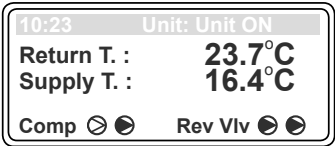
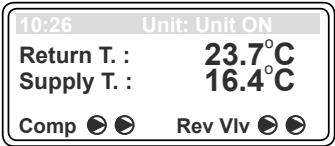
1.  Normal Heating Operation
2.  Call for Defrost System 1
3.  Comp. 1 Off
4.  Comp. 1 and Rev. Valve 1 Off
5.  Comp. 1 On Rev. Valve 1 Off
6.  Defrost Complete
7.  Comp. 1 Off
8.  Comp. 1 Off Rev. Valve 1 On
9.  Normal Heating Operation

Compressor 2 Defrost Operation

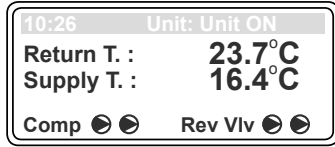
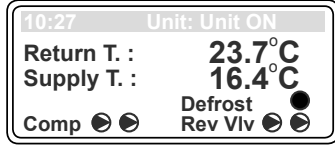
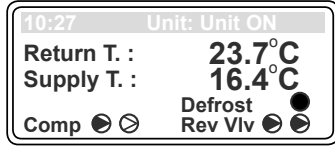
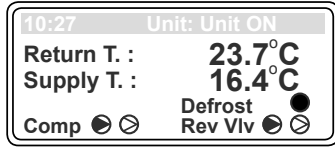
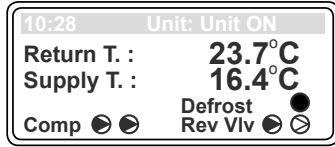
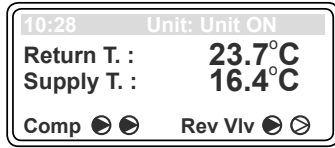
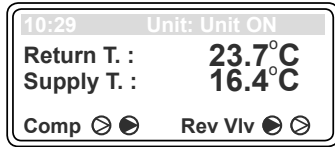
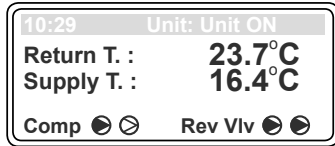
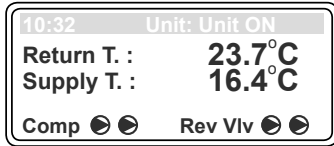
1.  Normal Heating Operation
2.  Call for Defrost System 2
3.  Comp. 2 Off
4.  Comp. 2 and Rev. Valve 2 Off
5.  Comp. 2 On Rev. Valve 2 Off
6.  Defrost Complete
7.  Comp. 2 Off
8.  Comp. 2 Off Rev. Valve 2 On
9.  Normal Heating Operation

MENU TREE DIAGRAM

CONSUMER / END USER MENU

Note: To toggle (scroll) "Up" or "Down" from existing menu, press "↓" or "↑" Button.

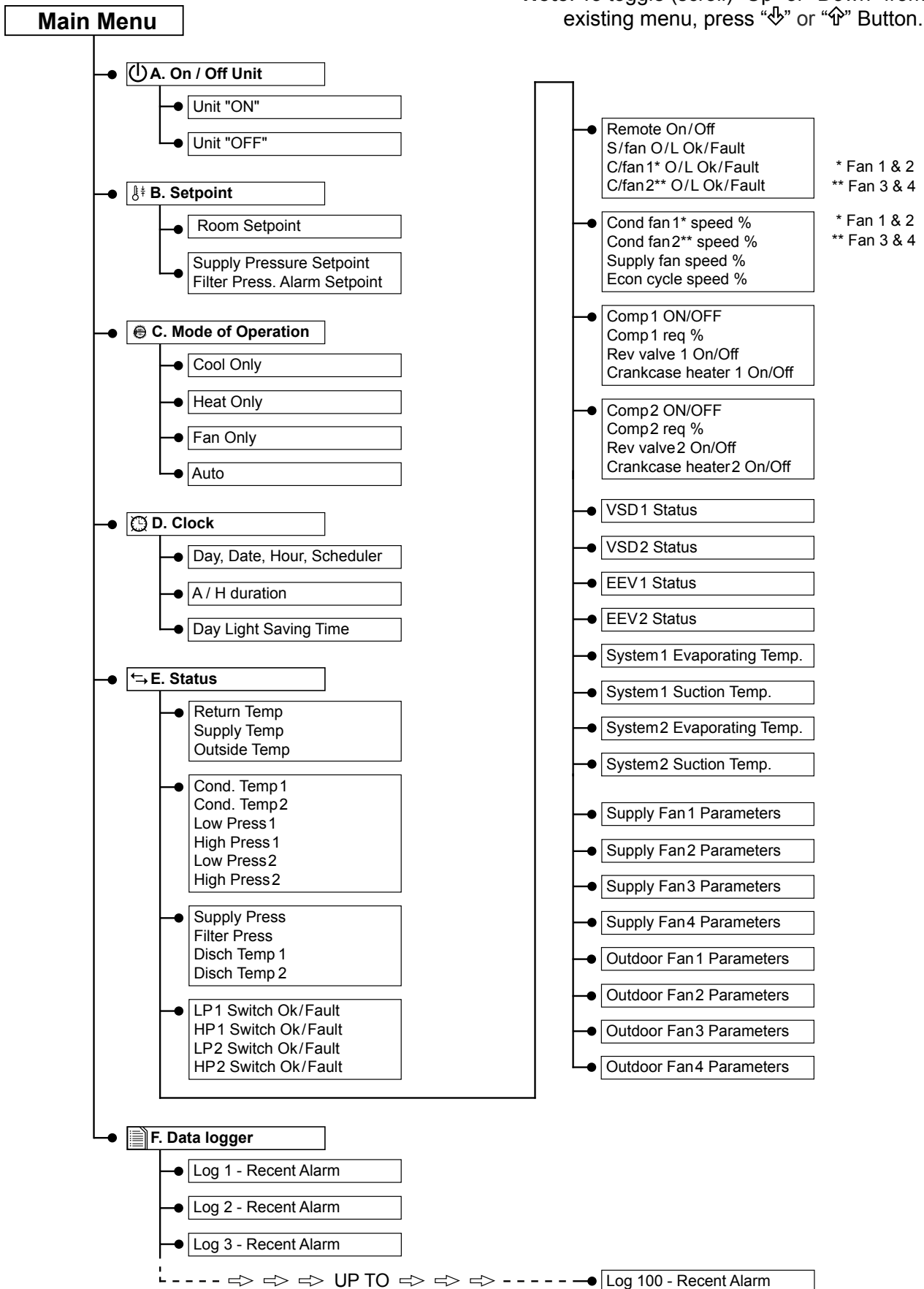

SUB-MENU LEVEL DESCRIPTIONS

A. On/Off Unit Sub-Menu Level 1

Menu screen to Turn ON / OFF the unit.

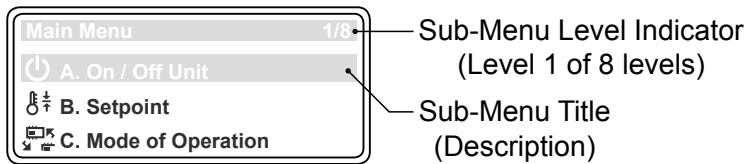

B. Setpoint Sub-Menu Level 2

Menu screen to set the room temperature.

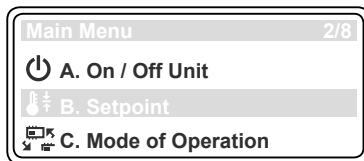

C. Mode of Operation Sub-Menu Level 3

Menu screen for selection of COOL, HEAT, FAN or AUTO CHANGEOVER operation.

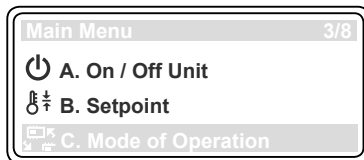

D. Clock Sub-Menu Level 4

Menu screen to set the date & time.

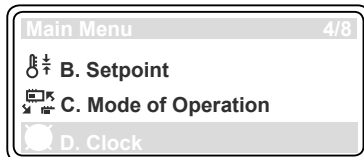

E. Status Sub-Menu Level 5

Read only Menu screen to view the unit running conditions, such as Supply/Return Air temperature, Airflow, Outside temperature, Condensing temperatures, LP/HP, Supply Air pressure, Discharge Temperatures, Fans Speed, Variable Speed Drive operating conditions, etc..

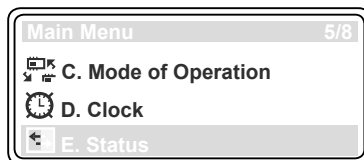

F. Data logger Sub-Menu Level

Read only Menu screen that indicates the alarm history

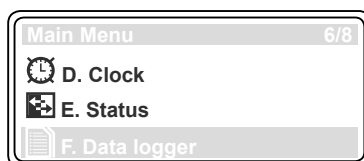

Note: Only up to level 6 covered by this manual are accessible by the end user.

OPERATION MODE

1. Press "**Prg**" Button to get into the Main Menu. Display will show Main Menu and highlighted Sub-Menu **A. On/Off Unit**.
2. Press "↓" Button to scroll down into **C. Mode of Operation** sub-menu.
3. Press "↵" Button to lock-in **C. Mode of Operation** sub-menu. Display will change into **Heat / Cool** mode selection menu showing **COOL ONLY** mode, **HEAT ONLY** mode, **FAN ONLY** mode or **AUTO CHANGE OVER** mode, depending on the previous mode selected.

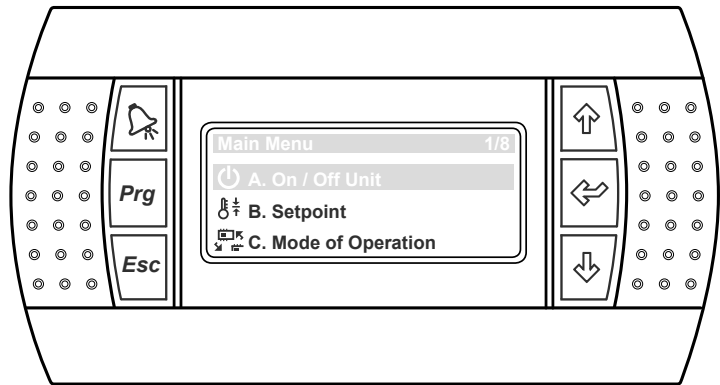

4. Press "↵" Button to change the mode and the cursor "█" will be blinking at the first letter of the current mode.

TO SELECT COOL ONLY MODE (from HEAT ONLY mode)

5. Press "↓" or "↑" Button to scroll into COOL ONLY mode. Display will show COOL ONLY mode with the cursor "█" still blinking.
6. Press "↵" Button to lock-in COOL ONLY mode, the cursor "█" will disappear indicating that the operation is now in COOL ONLY mode.

Note:

To Select **HEAT ONLY**, **FAN ONLY** or **AUTO CHANGE OVER** Mode, follow steps 4 to 6 above.

TO RETURN TO THE MAIN MENU

7. Keep pressing "**Esc**" (Escape/Return) Button until you get to the Main Menu screen

Display Progression

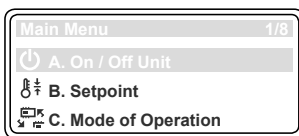

Step 1

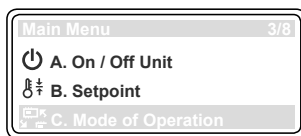

Step 2

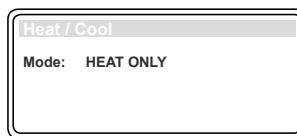

Step 3

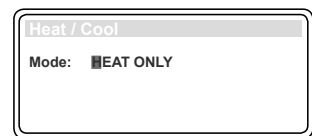

Step 4

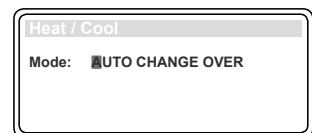
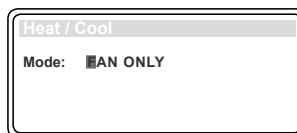
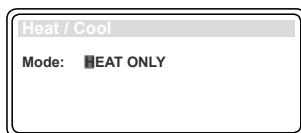
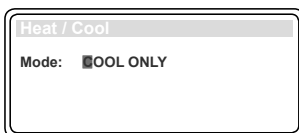

Step 5

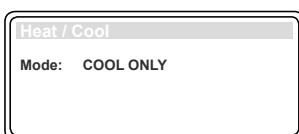

Step 6

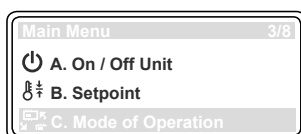

Step 7

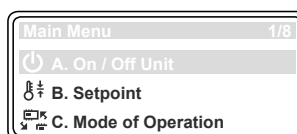

TURN ON/OFF

1. Press "**Prg**" Button to get into the Main Menu. Display will show Main Menu and highlighted Sub-Menu **A. On/Off Unit**.
2. Press "↵" Button to lock-in Sub-Menu **A. On/Off Unit**. Display will show the **ON/OFF** page with switch symbol pointing towards "OFF" position, indicating the unit is Turned-Off. (Symbol will be pointing towards "ON" position when unit is ON).

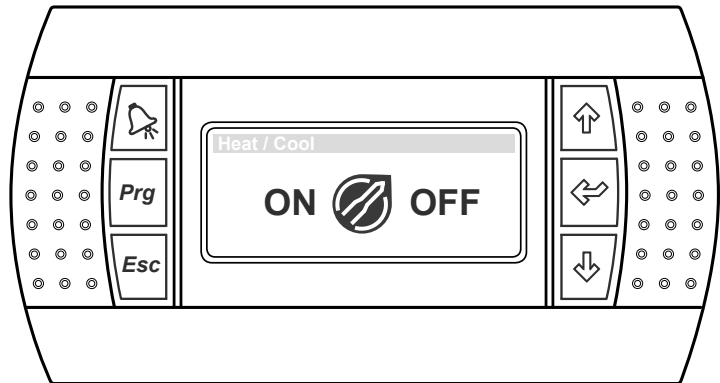

TO TURN-ON THE UNIT

3. Press "↵" Button, the cursor "■" will appear and blinking near "ON".
4. Press "↑" or "↓" Button to select switch "ON" position. Display will show the **ON/OFF** page with switch symbol pointing towards "ON" and the cursor "■" still blinking.
5. Press "↵" (Enter) Button to Turn-On the unit. The cursor "■" will disappear and the unit will Turn-On.

TO TURN-OFF THE UNIT

6. Repeat Steps 1 & 2, then press "↵" Button, cursor "■" will appear and blinking near "ON".
7. Press "↓" or "↑" Button to select switch "OFF" position. Display will show the **ON/OFF** page with switch symbol pointing towards "OFF" and the cursor "■" still blinking.
8. Press "↵" Button to Turn-Off the unit. The cursor "■" will disappear and the unit will Turn-Off.

TO RETURN TO THE MAIN MENU

9. Press "**Esc**" (Escape/Return) Button twice to return to the Main Menu. Otherwise press "**Prg**" Button.

Display Progression

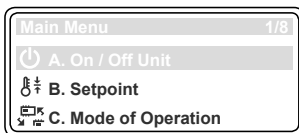

Step 1

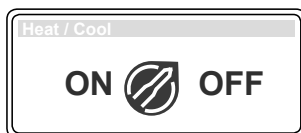

Step 2

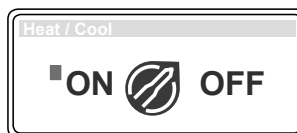

Step 3

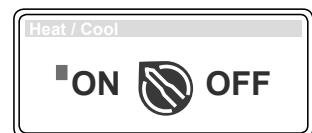

Step 4

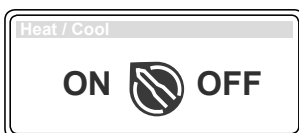

Step 5

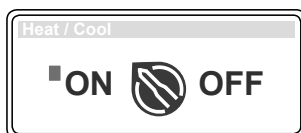

Step 6

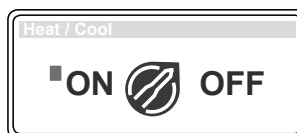

Step 7

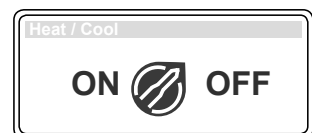

Step 8

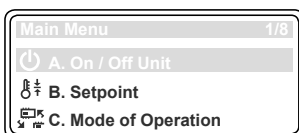

Step 9

SETTING ROOM TEMPERATURE SETPOINT

1. Press "**Prg**" Button to get into the Main Menu. Display will show Main Menu and highlighted Sub-Menu **A. On/Off Unit**.
2. Press "↓" Button to scroll down into **B. Setpoint** sub-menu.
3. Press "↵" Button to lock-in **B. Setpoint** sub-menu. "**Room setpoint**" (room set point temperature) screen will appear.

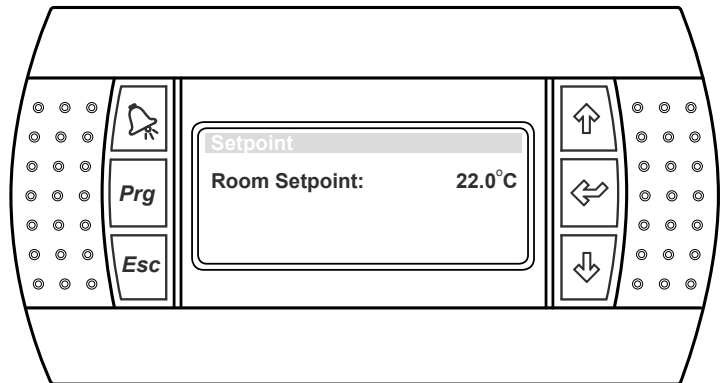

4. Press "↵" Button cursor "■" will appear and blink next to the setpoint temperature.
5. Press "↓" or "↑" Button to change room temperature setting.
Note: Temperature can be changed with an incremental/decremental value of 0.1°C.
6. Press "↵" Button to lock-in your desired room set point temperature. The cursor "■" will disappear and the new room setpoint temperature will be displayed.

TO RETURN TO THE MAIN MENU

7. Keep pressing "**Esc**" (Escape/Return) Button until you get to the Main Menu screen. Otherwise press "**Prg**" Button.

Display Progression

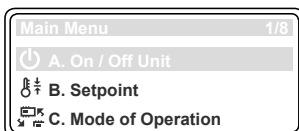

Step 1

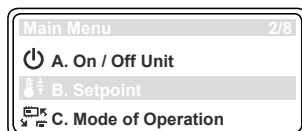

Step 2

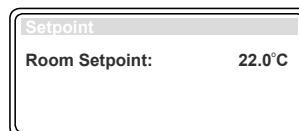

Step 3

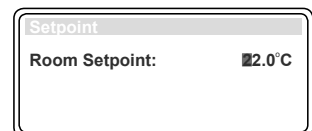

Step 4



Step 5



Step 6

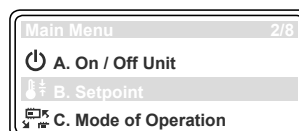

Step 7

SETTING SUPPLY AIR PRESSURE SETPOINT

1. Follow procedures 1-3 for Setting Room Temperature on previous page to lock into **B. Setpoint** sub-menu.
2. Press “↓” Button to scroll down into Supply Pressure Setpoint & Filter Alarm Setpoint screen. (**Setpoint 02**)
3. Press “↵” Button to lock-in **Setpoint 02** sub-menu. The cursor “█” will appear next to the Supply Pressure Setpoint.
4. Press “↓” or “↑” Button to change the Supply Pressure Setpoint.
Note: Supply Pressure Setpoint can be changed with an incremental/decremental value of 1Pa.
5. Press “↵” Button to lock-in your desired Supply Pressure Setpoint. The cursor “█” will move next to the Filter Pressure Alarm Setpoint. (See next page for Setting Filter Pressure Alarm Setpoint procedures).
6. Press “↵” Button again and the menu will prompt you to apply changes. The cursor “█” will move to Apply changes now prompt, next to "No" answer.
7. Press “↓” or “↑” Button to change prompt to "Yes".
8. Press “↵” Button to lock-in the new Supply Pressure Setpoint.

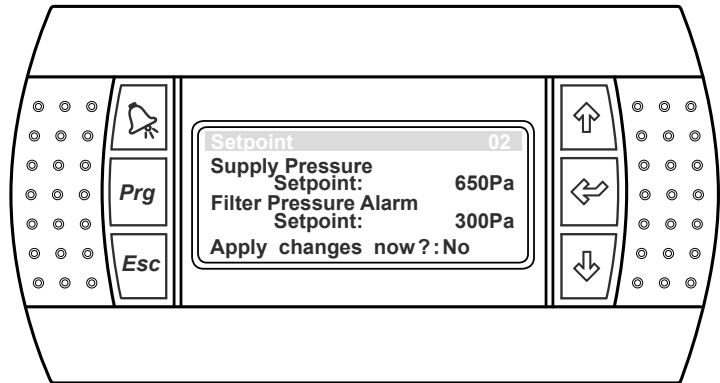

TO RETURN TO THE MAIN MENU

9. Keep pressing “**Esc**” (Escape/Return) Button until you get to the Main Menu screen. Otherwise press “**Prg**” Button.

Display Progression

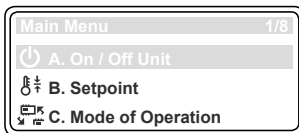

Step 1

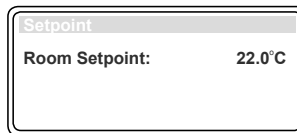
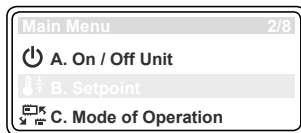

Step 2

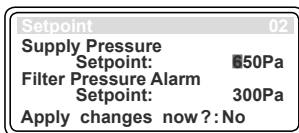
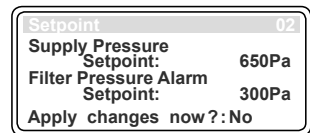

Step 3

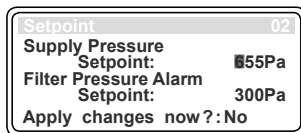

Step 4

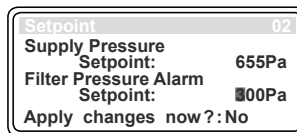

Step 5

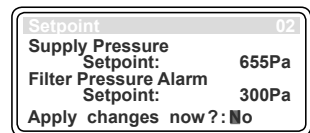

Step 6

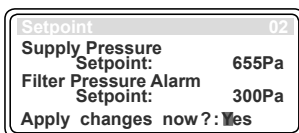

Step 7

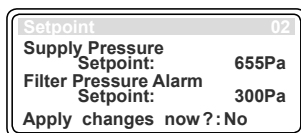

Step 8

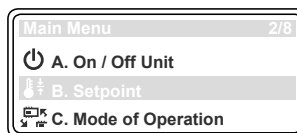

Step 9

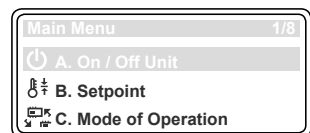

SETTING FILTER PRESSURE ALARM SETPOINT

1. Follow procedures 1-3 for Setting Pressure Setpoint on previous page to scroll down and lock into Supply Pressure Setpoint & Filter Alarm Setpoint screen (**Setpoint 02**). The cursor "█" will appear next to the Supply Pressure Setpoint.

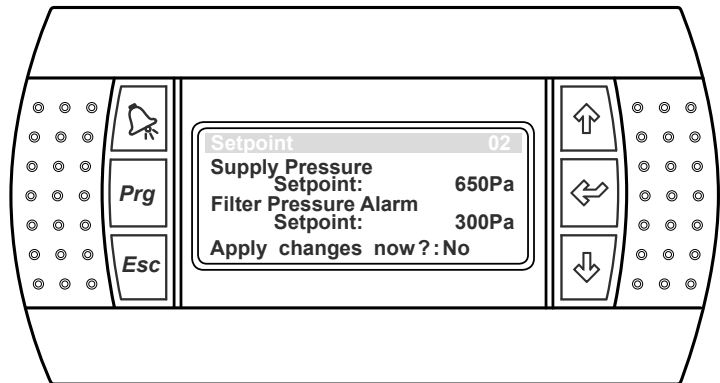

2. Press "↵" Button to move the cursor "█" down into Filter Pressure Alarm Setpoint.

3. Press "↓" or "↑" Button to change the Filter Pressure Alarm Setpoint.

Note: Filter Pressure Alarm Setpoint can be changed with an incremental/decremental value of 1Pa.

4. Press "↵" Button to lock-in your desired Filter Pressure Alarm Setpoint and the menu will prompt you to apply changes. The cursor "█" will move to Apply changes now prompt, next to "No" answer.

5. Press "↓" or "↑" Button to change prompt to "Yes".

6. Press "↵" Button to lock-in the new Filter Pressure Alarm Setpoint.

TO RETURN TO THE MAIN MENU

7. Keep pressing "Esc" (Escape/Return) Button until you get to the Main Menu screen. Otherwise press "Prg" Button.

Display Progression

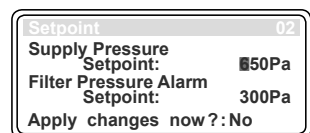
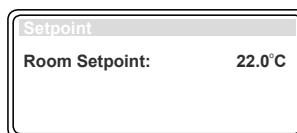
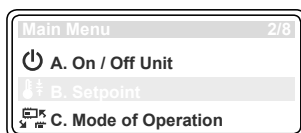
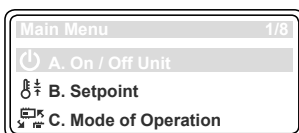

Step 1

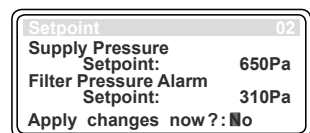
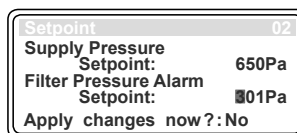
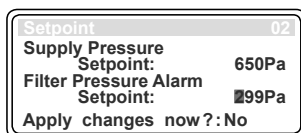
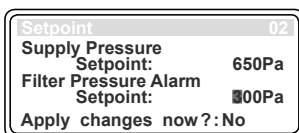

Step 2

Step 3

Step 4

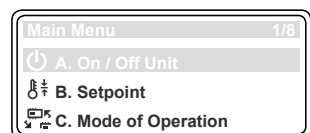
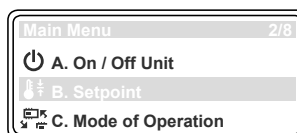
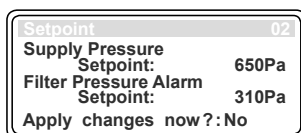
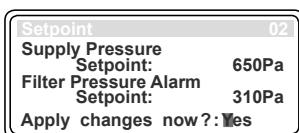

Step 5

Step 6

Step 7

SETTING THE CLOCK ...

1. Press "**Prg**" Button to get into the Main Menu. Display will show Main Menu and highlighted Sub-Menu **A. On/Off Unit**.
2. Press "↓" Button to scroll down into **D. Clock** sub-menu
3. Press "↵" Button to lock-in **D. Clock** sub-menu. Display will show the Day, Date, Time page and Scheduler.

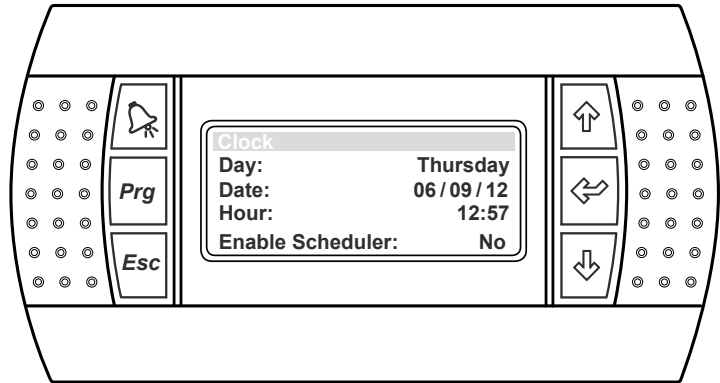

4. Press "↵" Button and the cursor "■" will appear next to the date indicator and the corresponding day will be shown, i.e. Thursday, 06/09/12 (6th September 2012).
5. Press "↓" or "↑" Button to change the date.
Note: Day changes corresponding to the change in date, as follows:
Wednesday, 05/09/12 (5th September 2012),
Friday, 07/09/12 (7th September 2012).
6. Press "↵" Button to lock-in the Date and the cursor "■" will move next to the month indicator.
7. Press "↓" or "↑" Button to change the month.
Note: Day changes corresponding to the change in month as follows:
Monday, 06/08/12 (8th August 2012),
Saturday, 06/10/12 (6th October 2012).
8. Press "↵" Button to lock-in the Month and the cursor "■" will move next to the year date.
9. Press "↓" or "↑" Button to change the year.
Note: Day changes corresponding to the change in year as follows:
Tuesday, 06/09/11 (6th September 2011),
Friday, 06/09/13 (6th September 2013).

Display Progression

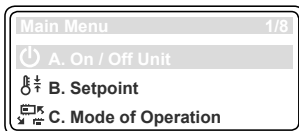

Step 1

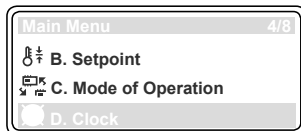

Step 2

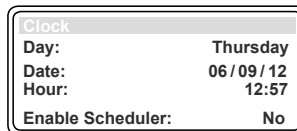

Step 3

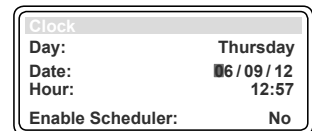

Step 4

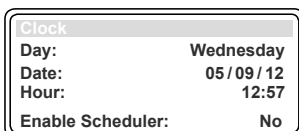

Step 5

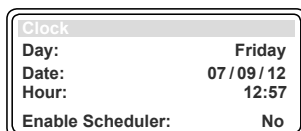

Step 6

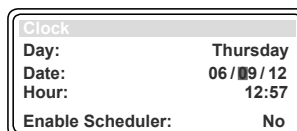

Step 7

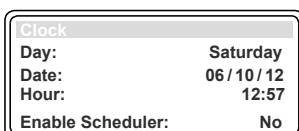
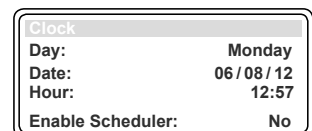

Step 7

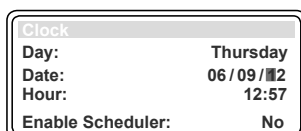

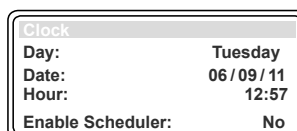

Step 8

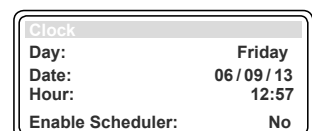

Step 9





... SETTING THE CLOCK

10. Press “” Button to lock-in the Year & Date and the cursor “” will move next to the hour indicator.



11. Press “” or “” Button to change the hour.

Note: Hour can be changed with an incremental value of 1 hour.

12. Press “” Button to lock-in the hour and the cursor “” will move next to the minute indicator.

13. Press “” or “” Button to change the minute.

Note: Minute can be changed with an incremental value of 1 minute.

14. Press “” Button to lock-in the minute and the cursor “” will disappear. Set date & time are now locked-in.

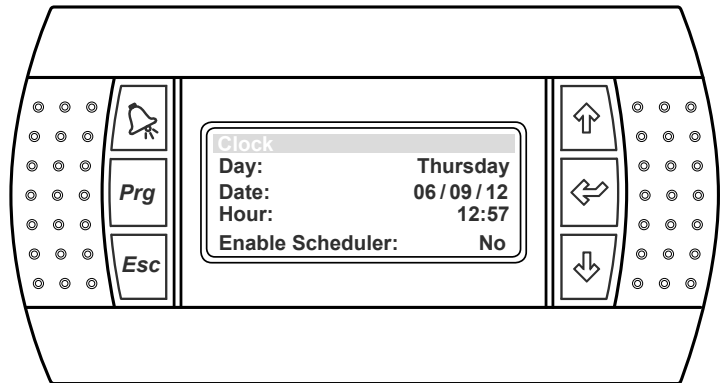

TO RETURN TO THE MAIN MENU

15. Keep pressing “**Esc**” (Escape/Return) Button until you get to the Main Menu screen. Otherwise press “**Prg**” Button.

Display Progression

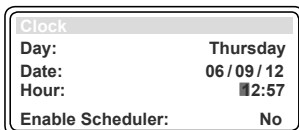

Step 10

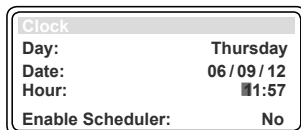

Step 11 (11:57)

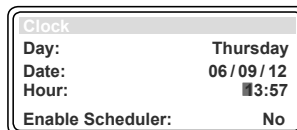

Step 11 (13:57)

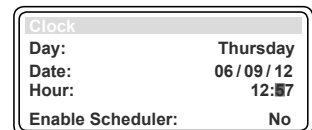

Step 12

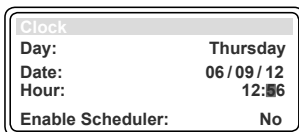

Step 13 (12:56)

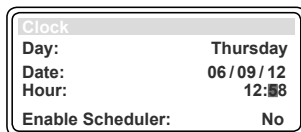

Step 13 (12:58)

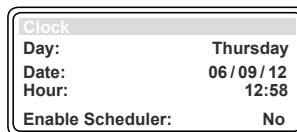

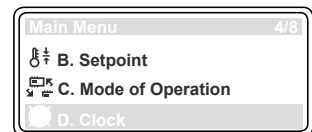

Step 14

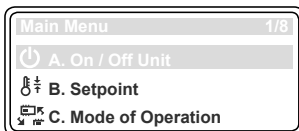

Step 15



Step 15

Note: Use the “” or “” Button to toggle on all of the **D. Clock** sub-menu functions.

7-DAY PROGRAMMING ...

1. From the main menu, scroll down into **D. Clock** sub-menu following the procedures from Setting the Clock.
2. Press "↵" Button repeatedly until the cursor "█" get down into **Enable Scheduler** sub-menu
3. Press "↓" or "↑" Button to prompt Enable Scheduler, "Yes" will replace "No" in this sub-menu with the cursor "█" flashing.
4. Press "↵" Button to enable the scheduler sub-menu, note the cursor "█" will disappear.
5. Press "↓" Button to scroll down into "**Clock Schedule 02**" sub-menu.
6. Press "↵" Button to lock-in the Clock Scheduler sub-menu and the cursor "█" will appear on Monday starting hour indicator.
7. Press "↓" or "↑" Button to change the hour.
Note: The time clock is in 24:00 format, i.e. 5:00 AM will be 05:00 and 5:00 PM will be 17:00.
8. Press "↵" Button to lock-in the time and the cursor "█" will move next to the minute indicator.
9. Press "↓" or "↑" Button to change the minute.

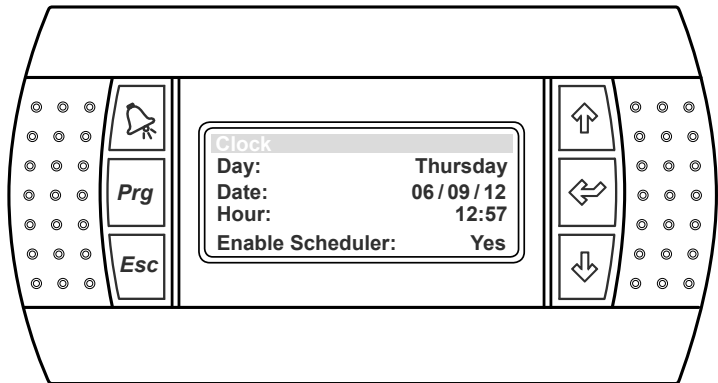

Display Progression

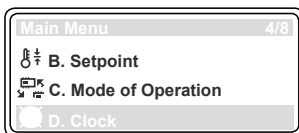

Step 1

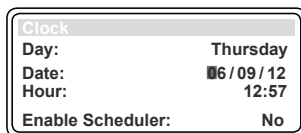

Step 2

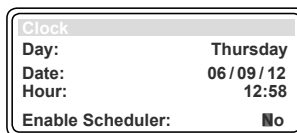

Step 3

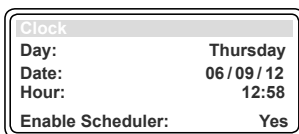

Step 4

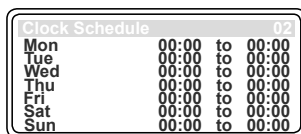

Step 5

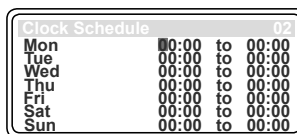

Step 6

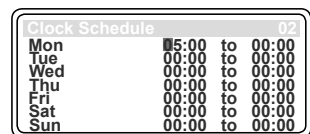

Step 7

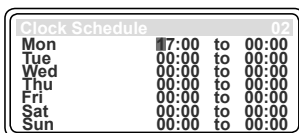

Step 7

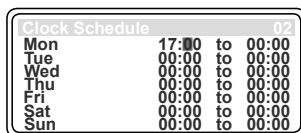

Step 8

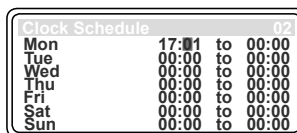

Step 9 (17:01)

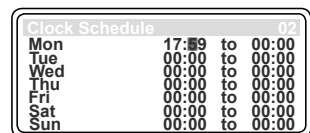

Step 9 (17:59)

... 7-DAY PROGRAMMING

10. Press to lock-in Monday starting time, the cursor will now move to Monday ending hour indicator.
Example: Monday starting time is set at 5:00 PM, i.e. 17:00.
11. Repeat steps 7- 10 to set up Monday ending time and the cursor will next move to Tuesday starting hour indicator.
Example: Monday ending time is set at 10:30 PM, i.e. 22:30.

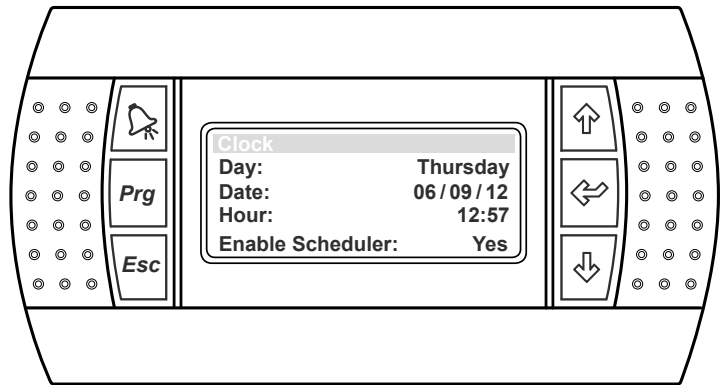

12. Repeat steps 7- 12 to set up the succeeding days programming start and end times.
Note: The scheduled program for each nominated day will be in operation every time each nominated day occurs during the year, i.e. the program for Monday will be repeated on every Monday, until the program is revised.

The scheduled time may need to be synchronized with the daylight saving time. See daylight saving time set-up procedures.

TO RETURN TO THE MAIN MENU

13. Keep pressing “**Esc**” (Escape/Return) Button until you get to the Main Menu screen. Otherwise press “**Prg**” Button.

Display Progression

Clock Schedule		02
Mon	17:00 to	00:00
Tue	00:00 to	00:00
Wed	00:00 to	00:00
Thu	00:00 to	00:00
Fri	00:00 to	00:00
Sat	00:00 to	00:00
Sun	00:00 to	00:00

Step 10

Clock Schedule		02
Mon	17:00 to	22:30
Tue	00:00 to	00:00
Wed	00:00 to	00:00
Thu	00:00 to	00:00
Fri	00:00 to	00:00
Sat	00:00 to	00:00
Sun	00:00 to	00:00

Step 11

Clock Schedule		02
Mon	17:00 to	22:30
Tue	18:00 to	21:30
Wed	19:00 to	21:00
Thu	19:00 to	21:00
Fri	18:00 to	22:30
Sat	08:00 to	18:00
Sun	10:00 to	17:00

Step 12

Main Menu		4/8
B. Setpoint		
C. Mode of Operation		
D. Clock		

Step 13

Main Menu		1/8
A. On / Off Unit		
B. Setpoint		
C. Mode of Operation		

Step 13

Note: Use the “**↓**” or “**↑**” Button to toggle on all of the **D. Clock** sub-menu functions.

AFTER HOUR TIMER

1. From the main menu, scroll down into **D. Clock** sub-menu following the procedures from Setting the Clock section.
2. Press “↓” Button to scroll down into **A/H duration** sub-menu.
3. Press “↵” Button to lock-in **A/H duration** sub-menu and the cursor “■” will appear on After Hour time indicator.
4. Press “↓” or “↑” Button to select the duration of after hour timer.
Note: The duration of the after hour timer can be set in 1 hour increment up to 8 hour maximum.
5. Press “↵” Button to lock-in the selected after hour duration, note the cursor “■” will disappear and the selected duration will be displayed. i.e. 1 hour (1 H).

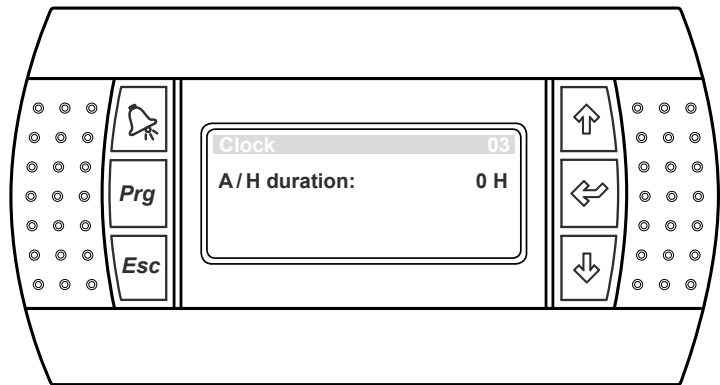

TO RETURN TO THE MAIN MENU

6. Keep pressing “**Esc**” (Escape/Return) Button until you get to the Main Menu screen. Otherwise press “**Prg**” Button.

Display Progression

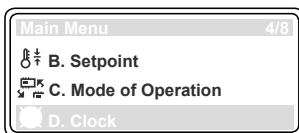

Step 1

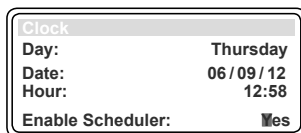

Step 2

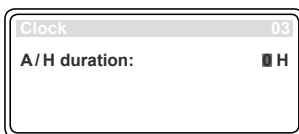
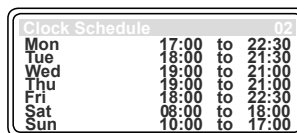

Step 3

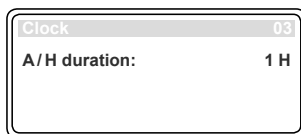

Step 4

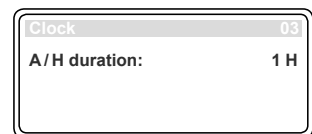
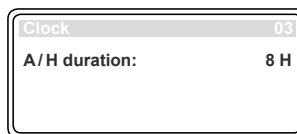

Step 5

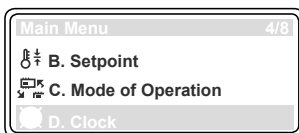

Step 6

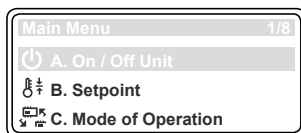

Note: Use the “↓” or “↑” Button to toggle on all of the **D. Clock** sub-menu functions.

DAYLIGHT SAVING TIME ENABLE ...

1. From the main menu, scroll down into **D. Clock** sub-menu following the procedures from Setting the Clock section.
2. Press "↓" Button to scroll down into **Daylight Saving Time** sub-menu.
3. Press "↵" Button to lock-in **Daylight Saving Time** sub-menu and the cursor "█" will appear on "ENABLE" indicator.
4. Press "↵" Button again to enable **Daylight Saving Time** mode and the cursor "█" will move to the "Transition time" segment.
5. Press "↓" or "↑" Button to select the number of minutes for transition into daylight saving time..
Note: The transition time can be set in 1 minute increment up to 60 minutes maximum.
6. Press "↵" Button to lock-in the selected length of transition time, i.e. 60min. The cursor "█" will next move into the Sunday for the start of the transition to occur.
7. Press "↓" or "↑" Button to select the "Sunday" for the transition into daylight saving time.
Note: The "Sunday" transition can be set as First Sunday, Second... Fourth or Last Sunday.
8. Press "↵" Button to lock-in the Sunday for the transition to occur, i.e. FIRST SUNDAY. The cursor "█" will next move into the starting month selection segment.
9. Press "↓" or "↑" Button to select the "Month" for the transition into daylight saving time.
10. Press "↵" Button to lock-in the Month for the transition to occur, i.e. October. The cursor "█" will next move into the starting time selection segment.

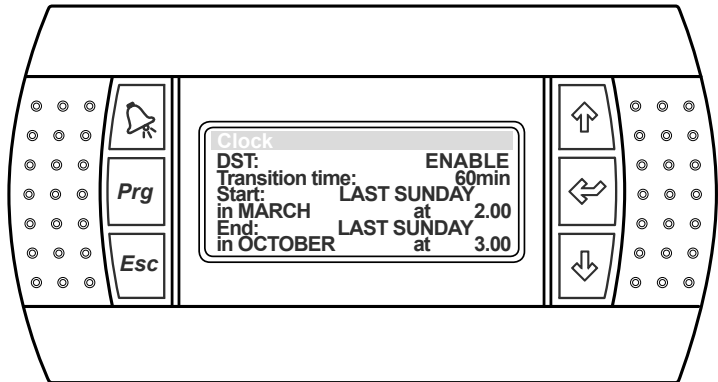

Display Progression

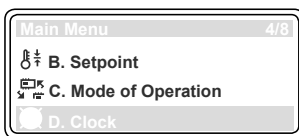

Step 1

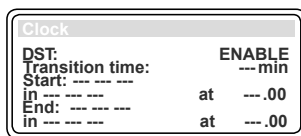

Step 2

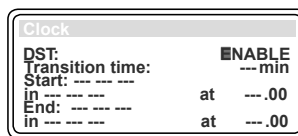

Step 3

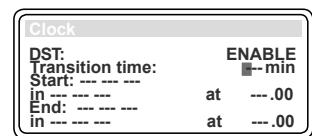

Step 4



Step 5



Step 6

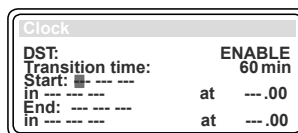

Step 7

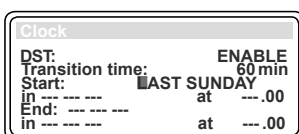
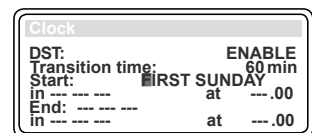

Step 7

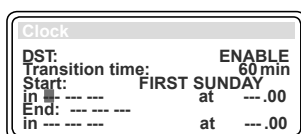

Step 8

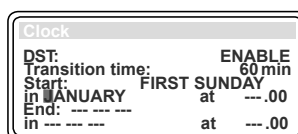

Step 9 (January)

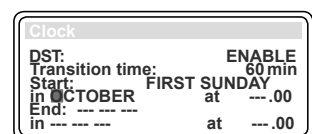

Step 9 (October)

... DAYLIGHT SAVING TIME ENABLE

11. Press “↓” or “↑” Button to select the "hour" on the Sunday for the transition into daylight saving time.

Note: The time clock is in 24:00 format, i.e. 2:00 AM will be 2.00 and 8:00 PM will be 20.00.

12. Press “↔” Button to lock-in the time on the Sunday for the transition to occur, i.e. 2.00. The cursor “█” will next move into the Sunday for the transition to end.

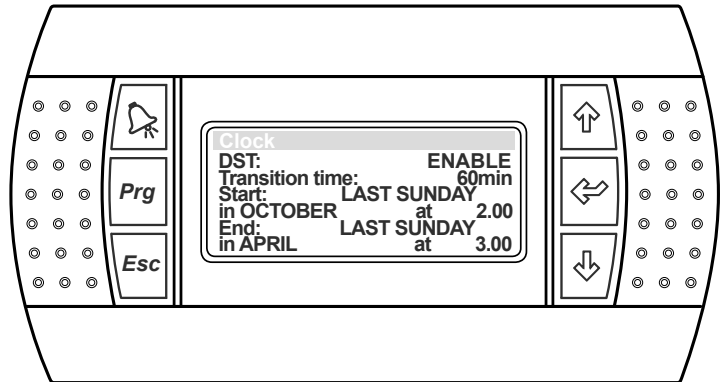

13. Repeat steps 7- 11 to set up the end of Daylight Saving Time parameters.

14. Press “↔” Button to enable the Daylight Saving Time and lock-in the parameters.

TO RETURN TO THE MAIN MENU

15. Keep pressing “Esc” (Escape/Return) Button until you get to the Main Menu screen. Otherwise press “Prg” Button.

Display Progression

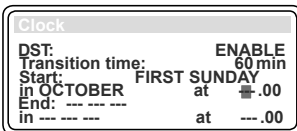

Step 10

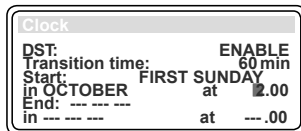

Step 11 (2.00)

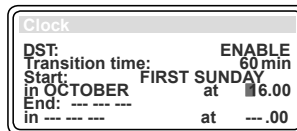

Step 11 (16.00)

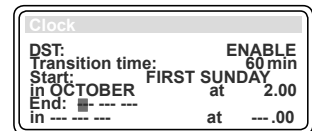

Step 12

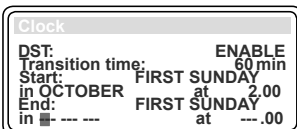

Step 13

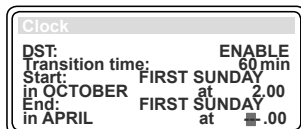

Step 14

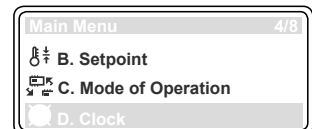
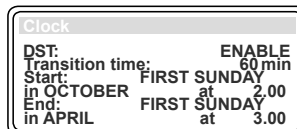

Step 15

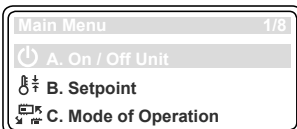

Step 15

Note: Use the “↓” or “↑” Button to toggle on all of the **D. Clock** sub-menu functions.

DAYLIGHT SAVING TIME DISABLE

1. From the main menu, scroll down into **D. Clock** sub-menu following the procedures from Setting the Clock section.
2. Press “↓” Button to scroll down into **Daylight Saving Time** sub-menu.
3. Press “↵” Button to lock-in **Daylight Saving Time** sub-menu and the cursor “█” will appear on "ENABLE" indicator.

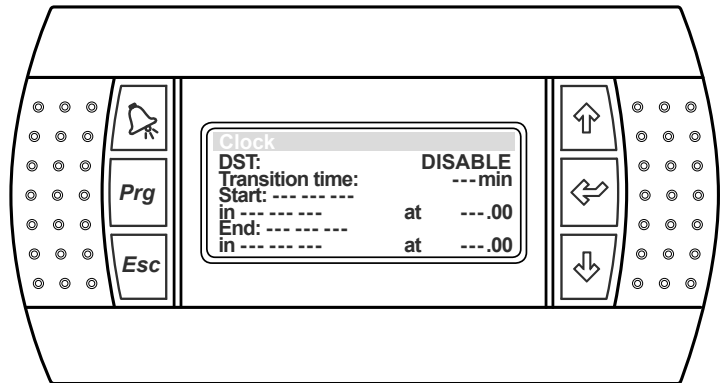

4. Press “↓” or “↑” Button to select the "**DISABLE**" Daylight Saving Time function.
Note: The segment will change from "**ENABLE**" to "**DISABLE**".
5. Press “↵” Button to disable the **Daylight Saving Time** function. The cursor will disappear and the "DISABLE" sub-menu screen will be displayed.

TO RETURN TO THE MAIN MENU

6. Keep pressing “**Esc**” (Escape/Return) Button until you get to the Main Menu screen. Otherwise press “**Prg**” Button.

Display Progression

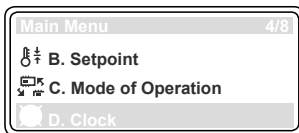

Step 1

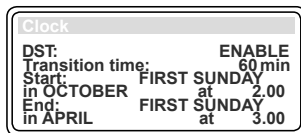

Step 2

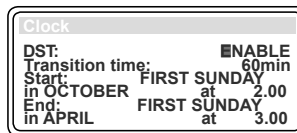

Step 3

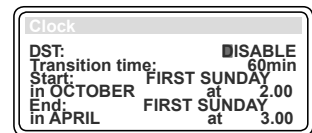

Step 4 (DISABLE)



Step 5

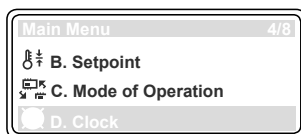

Step 6

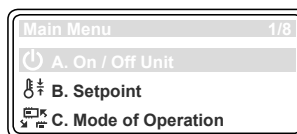

- Notes:**
1. Use the “↓” or “↑” Button to toggle on all of the **D. Clock** sub-menu functions.
 2. The programmed Day Light Saving Time parameters will be retained for next time Day Light Saving Time is enabled.

STATUS (Read Only Menu)

1. Press "**Prg**" Button to get into the Main Menu. Display will show Main Menu and highlighted Sub-Menu **A. On/Off Unit**.

2. Press "↓" Button to scroll down into **E. Status** sub-menu.

3. Press "↵" Button to lock-in **E. Status** sub-menu. Display will show the first screen under this sub-menu.

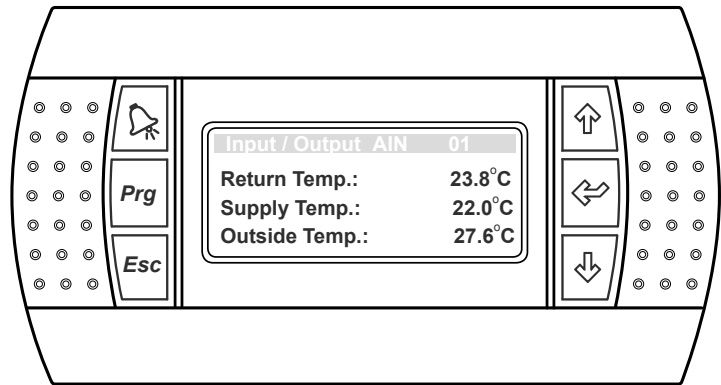

4. Press "↓" Button to scroll down into the second screen and view the operating parameters.

5. Press "↓" Button repeatedly to scroll down into the next succeeding operating parameter screens.

6. Press "↑" Button to scroll up and to view the previews screens.

TO RETURN TO THE MAIN MENU

7. Keep pressing "**Esc**" (Escape/Return) Button until you get to the Main Menu screen. Otherwise press "**Prg**" Button.

Display Progression

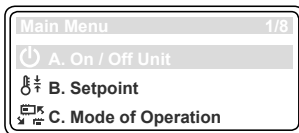

Step 1

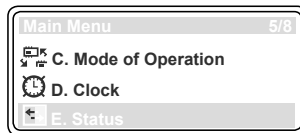

Step 2

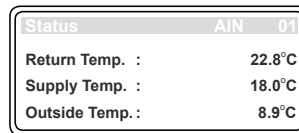

Step 3

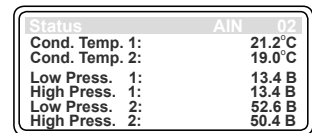

Step 4

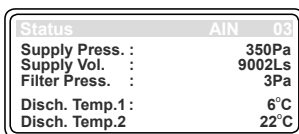

Step 5

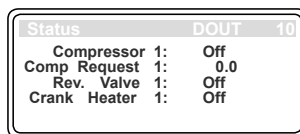

Step 6

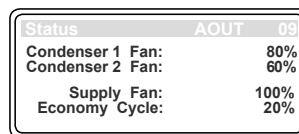

Step 7

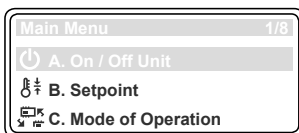
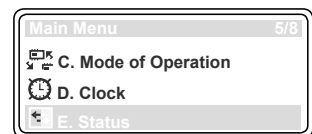

Step 7

DATA LOGGER (Read Only Menu)

1. Press "**Prg**" Button to get into the Main Menu. Display will show Main Menu and highlighted Sub-Menu **A. On/Off Unit**.

2. Press "↓" Button to scroll down into **F. Data logger** sub-menu.

3. Press "↵" Button to lock-in **F. Data logger** sub-menu. Display will show the first screen under this sub-menu.
Note: Data logger is time & date stamped.

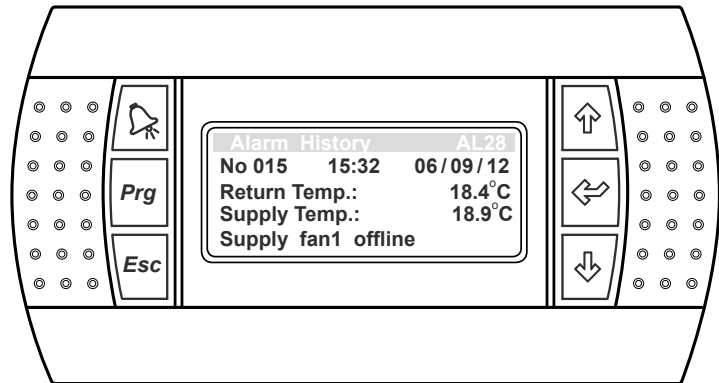

4. Press "↓" Button to scroll down into the second screen and view the alarm history.

5. Press "↓" Button repeatedly to scroll down into the next succeeding screens and view the other alarm log.

6. Press "↑" Button to scroll up and to view the previews alarm history screens.

TO RETURN TO THE MAIN MENU

7. Keep pressing "**Esc**" (Escape/Return) Button until you get to the Main Menu screen. Otherwise press "**Prg**" Button.

TO RESET THE ALARM

8. Press the "🔔" Button twice to reset or clear the alarm.

Important Note:

All alarm fault conditions must be investigated and rectified before proceeding to reset or clear the alarm. If the cause of the fault condition has not been eliminated, the alarm fault conditions will be reported and logged in again on next data cycle. **Repeated resetting and restarting can cause damage to the unit and may invalidate the warranty.**

Display Progression

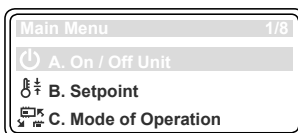

Step 1

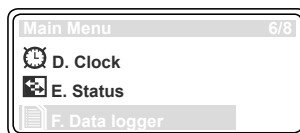

Step 2

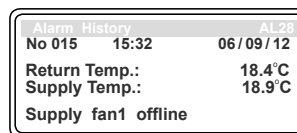

Step 3

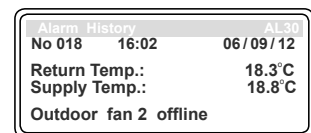

Step 4

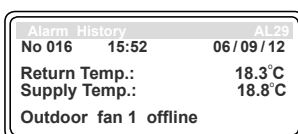

Step 5

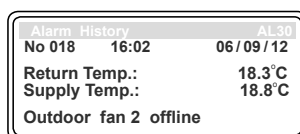

Step 6

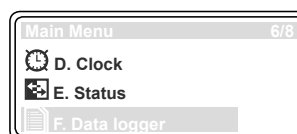

Step 7

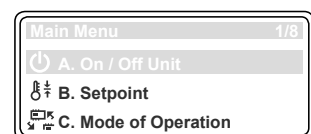

DUAL CONTROL OPERATION

MIMIC CONTROL

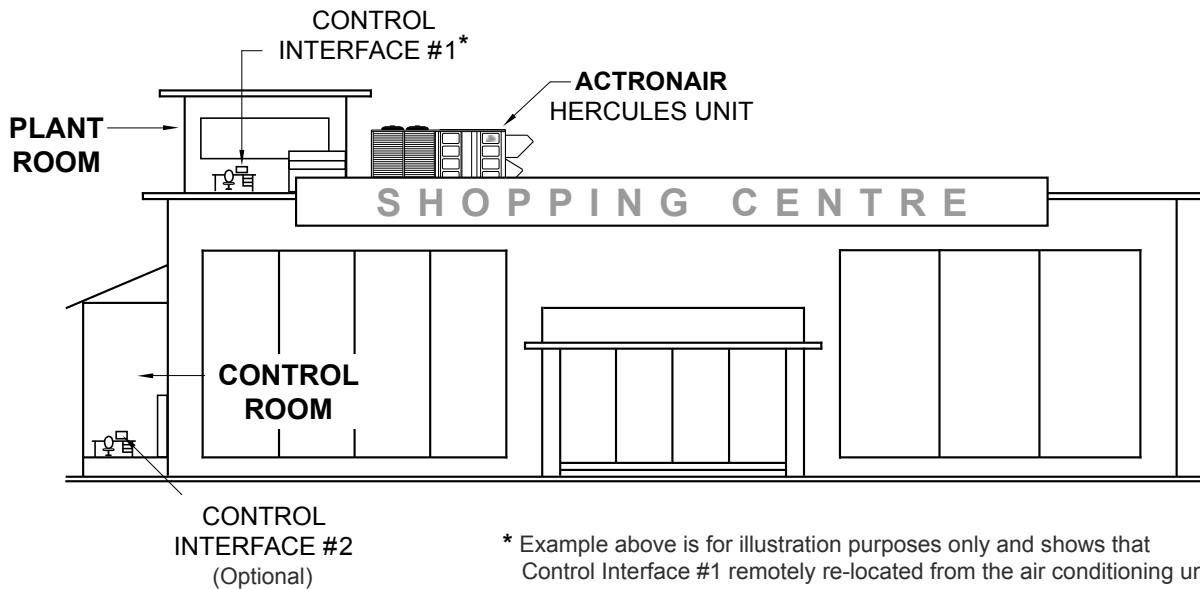

MIMIC CONTROL OPERATION

- The air conditioning system can be operated from either of the two control interfaces.
- Information displayed on the control interfaces are identical.
- Last control interface used has the priority.

Example 1:

Using Control Interface #1, the cooling operation is started, both control interfaces will now show the system is in cooling mode. If another person uses Control Interface #2 to select heating mode, the system will now change to heating operation and both controls will display that the system is in heating mode.

Example 2:

Using Control Interface #2, the Room Setpoint temperature is set at 16.0°C, both control interfaces will now show that the room setpoint temperature is at 16.0°C. If another person uses Control Interface #1 to change the setpoint temperature to 18.0°C, the system will now be operating at the new Room Setpoint Temperature and both controls will display the same setpoint temperature.

Controllers Compatibility Matrix for Dual Control

Combination Options	Controller	Controller
Option 1	ActronAir Control Interface	ActronAir Control Interface
Option 2	ActronAir Control Interface	BMS Controller

ALARM MATRIX

Serial Number	Description	Type	Start Condition	Stop Condition
1	Compressor 1 HP fault	Alarm	Pd > 4216kPa	Pd < 2647kPa
2	Compressor 2 HP fault	Alarm	Pd > 4216kPa	Pd < 2647kPa
3	Compressor 1 LP fault	Alarm	Ps < 401kPa	Ps > 686kPa
4	Compressor 2 LP fault	Alarm	Ps < 401kPa	Ps > 686kPa
5	Compressor 1 overload	Alarm	Drive alarm high current	Current less than 90% of maximum
6	Compressor 2 overload	Alarm	Drive alarm high current	Current less than 90% of maximum
7	Compressor 1 offline	Alarm	Communication loss	Communication OK
8	Compressor 2 offline	Alarm	Communication loss	Communication OK
9	Evaporator Fan 1 offline	Alarm	Communication loss	Communication OK
10	Evaporator Fan 2 offline	Alarm	Communication loss	Communication OK
11	Evaporator Fan 3 offline	Alarm	Communication loss	Communication OK
12	Evaporator Fan 4 offline	Alarm	Communication loss	Communication OK
13	Condenser Fan 1 offline	Alarm	Communication loss	Communication OK
14	Condenser Fan 2 offline	Alarm	Communication loss	Communication OK
15	Condenser Fan 3 offline	Alarm	Communication loss	Communication OK
16	Condenser Fan 4 offline	Alarm	Communication loss	Communication OK
17	Probe 1 Faulty / Wiring open or short circuit	Warning	Return Air temperature sensor fault	Sensor OK
18	Probe 2 Faulty / Wiring open or short circuit	Warning	Supply Air temperature sensor fault	Sensor OK
19	Probe 3 Faulty / Wiring open or short circuit	Alarm	Suction Comp 1 temperature sensor fault	Sensor OK
20	Probe 4 Faulty / Wiring open or short circuit	Alarm	Suction Comp 2 temperature sensor fault	Sensor OK
21	Probe 6 Faulty / Wiring open or short circuit	Alarm	Low pressure Comp 1 temperature sensor fault	Feedback signal OK
22	Probe 7 Faulty / Wiring open or short circuit	Alarm	Low pressure Comp 2 temperature sensor fault	Feed back signal OK
23	Probe 8 Faulty / Wiring open or short circuit	Warning	Outdoor coil Comp 1 temperature sensor fault	Sensor OK
24	Probe 9 Faulty / Wiring open or short circuit	Warning	Outdoor coil Comp 2 temperature sensor fault	Sensor OK
25	Probe 10 Faulty / Wiring open or short circuit	Warning	Outside air temperature sensor fault	Sensor OK
26	Probe 11 Faulty / Wiring open or short circuit	Alarm	High Pressure Comp 1 pressure sensor fault	Feed back signal OK
27	Probe 12 Faulty / Wiring open or short circuit	Alarm	High Pressure Comp 2 pressure sensor fault	Feed back signal OK
28	Filter Differential Pressure alarm	Warning	Filter Dirty	Filter Clean
29	Filter Differential Pressure sensor fault	Warning	Air pressure < 15 Pa and fan speed > 250rpm	Air pressure > 15 Pa and fan speed > 250rpm
30	Supply Air pressure sensor fault	Warning	Air pressure < 15 Pa and fan speed > 250rpm	Air pressure > 15 Pa and fan speed > 250rpm

TROUBLE SHOOTING GUIDE

CONDITION	PROBABLE CAUSE	RECOMMENDED ACTIONS / CHECKPOINTS
Unit will not operate	No Power to the unit No power to the variable speed drive Unit under fault condition	Check whether the mains power switch is ON. Check whether the Drive Circuit breakers are switched ON. Check the Fault details.
Unit will not Cool or Heat, only Fan operates	The mode of operation is "Fan only". Indoor condition is equal to the set point	Set the correct mode of operation. Try setting the min setpoint for Cooling 16°C (If cooling required). Try setting the max setpoint for Heating 28°C (If heating required)
Unit Cools or Heats, but will not control to setpoint	Return air sensor is defective. Return air sensor wrongly calibrated.	Check the Alarm on the Control Interface. Need to correct the calibration through service
Compressor 1 or 2 will not operate, outdoor fan will operate	Head pressure high Discharge pressure sensor faulty.	Check the Alarm on the Control Interface.
Compressor 1 or 2 will not operate, outdoor fan will also not operate	The mode of operation is "Fan Only".	Set the correct mode of operation
Outdoor Motor will not operate	Motor in fault. Head pressure not above the set limit for the fan to start.	Check the Alarm on the Control Interface. Need to correct the setpoint through service.
Indoor Motor will not operate	Motor in fault. Supply air pressure sensor faulty.	Check the Alarm on the Control Interface.
Crankcase Heater will not operate	Heater contactor has failed. Heater element has failed. Wiring or terminal failure	Check the Crankcase heater switching setting through service. Replace heater element through service. Check wiring or terminal and replace as required through service.

TROUBLE SHOOTING GUIDE

CONDITION	PROBABLE CAUSE	RECOMMENDED ACTIONS / CHECKPOINTS
Evaporator coil freezes up during low ambient operation	System low on refrigerant. System low on airflow. Outdoor air sensor failure.	Check the pressures and the temps for suction and discharge. Check the ID fan airflow through the Control Interface. Check the Alarm on the Control Interface.
Economiser, outside air and/or spill air will not operate	Economiser connector not plugged into unit wiring harness Economiser, outside air, and/or spill air motor has failed. Wiring or terminal failure	Check the connection. Motor wiring to be checked and replaced as required. Wiring or terminal to be checked and replaced as required.
Control Interface keys not operating	Control Interface hanged. RJ12 cable failure.	Reset the power to the Control Interface by turning it OFF/ON. Replace RJ12 cable through service.
Control Interface does not power up	Wiring fault. RJ12 cable fault.	Wiring to be checked as per the wiring diagram. Replace RJ12 cable through service.

MAINTENANCE

Maintenance Procedures

This section describes the specific maintenance procedures that must be performed as a part of normal maintenance program. Always disconnect electrical power to the unit before performing these procedures. It is always a safe practice to observe all safety warnings and cautions when conducting maintenance tasks.

DANGER

Live Electrical Connections !

It may be necessary to work near live electrical components on certain maintenance tasks. Only licensed electricians and/or qualified technicians who are competently trained are allowed to perform service tasks.

WARNING

Hazardous Voltage !

Always make sure that all power supplies, including remote controls, are isolated before performing maintenance. Observe proper Lock-Out / Tag-Out procedures to ensure that power cannot be inadvertently energised. Failure to isolate power before maintenance procedures can result in serious injury or death.

Periodic Maintenance Checkpoint

- Perform all monthly maintenance inspections
- Inspect coil surfaces for cleanliness. Clean as required, apply cleaning procedures based on prevailing industry standard.
- Inspect unit air filters, clean or replace as required.

Annual Maintenance Checklists

- Perform general maintenance inspections.
- Perform scheduled start-up checks.
- Leak test refrigerant circuits.
- Inspect contacts of all contactors and relays. Replace all worn contacts as required.
- Inspect, clean and tighten all electrical connections.
- Check fans for balanced operation. Make sure that there are no loose screws/bolts, no fan blades interference and no damage to the fans and guards.
- Inspect unit air filters, clean or replace as required.
- Clean and repaint any corroded panel surface.

Cleaning the Control Interface

Wipe the control interface with dry cloth. Do not use water or any other solvent base solutions as it can cause damage to the outer case and electronic components of the controller.

Air Filter Maintenance.

Regularly check the air filters for cleanliness or when a filter alarm is indicated on the control interface.

Cleaning the Condenser Coils

Clean the coils at least once a year or more frequently if unit is located in a dusty and/or dirty environment, in order to maintain your system's proper operating performance. High discharge pressures are a good indication that the coils need cleaning. When using detergent or solvents to clean the coils, follow the manufacturer's instructions to avoid potential damage to the coils and to the unit.

To clean the refrigerant coils, use a soft brush and water spray, such as garden hose or pressure washer with low pressure nozzle.

Outdoor Maintenance

Do not obstruct airflow to the outdoor coil to ensure your air conditioner operates efficiently. Use light detergent solutions to clean the surface of the panels. Repaint corroded panel surface, as required.

SYSTEM INFORMATION

CUSTOMER INFORMATION

Name:

Tel. Number:

Address:

INSTALLER INFORMATION

Company Name:

Address:

Tel. Number:

Fax. Number:

Technician - Name:

Tel. Number:

Fax. Number:

UNIT INFORMATION

Model Number:

Serial Number:

The air conditioner model and serial number is situated on the side panel of the unit's bottom left corner, near the compressor compartment.

Date Installed:

THIS PAGE INTENTIONALLY LEFT BLANK



ActronAir®

Australian for air conditioning™

1800 119 229

www.actronair.com.au



Actron Engineering Pty Ltd

ABN 34 002 767 240

HEAD OFFICE SYDNEY AUSTRALIA

Printed in Australia
Part No. 0525-022
Version No. 2.0 130408